

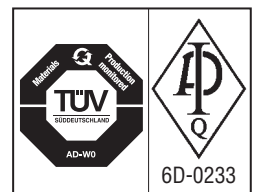

N. 0 ULTRASTAR TYPE TRUNNION MOUNTED FORGED STEEL BALL VALVES



CE 0038
Module H Category III





?CBGHFI ?79!'A5H9F-â @

DESIGN FOR:
 1/2" to 4" Full Bore
 3/4" to 6" Reduced Bore

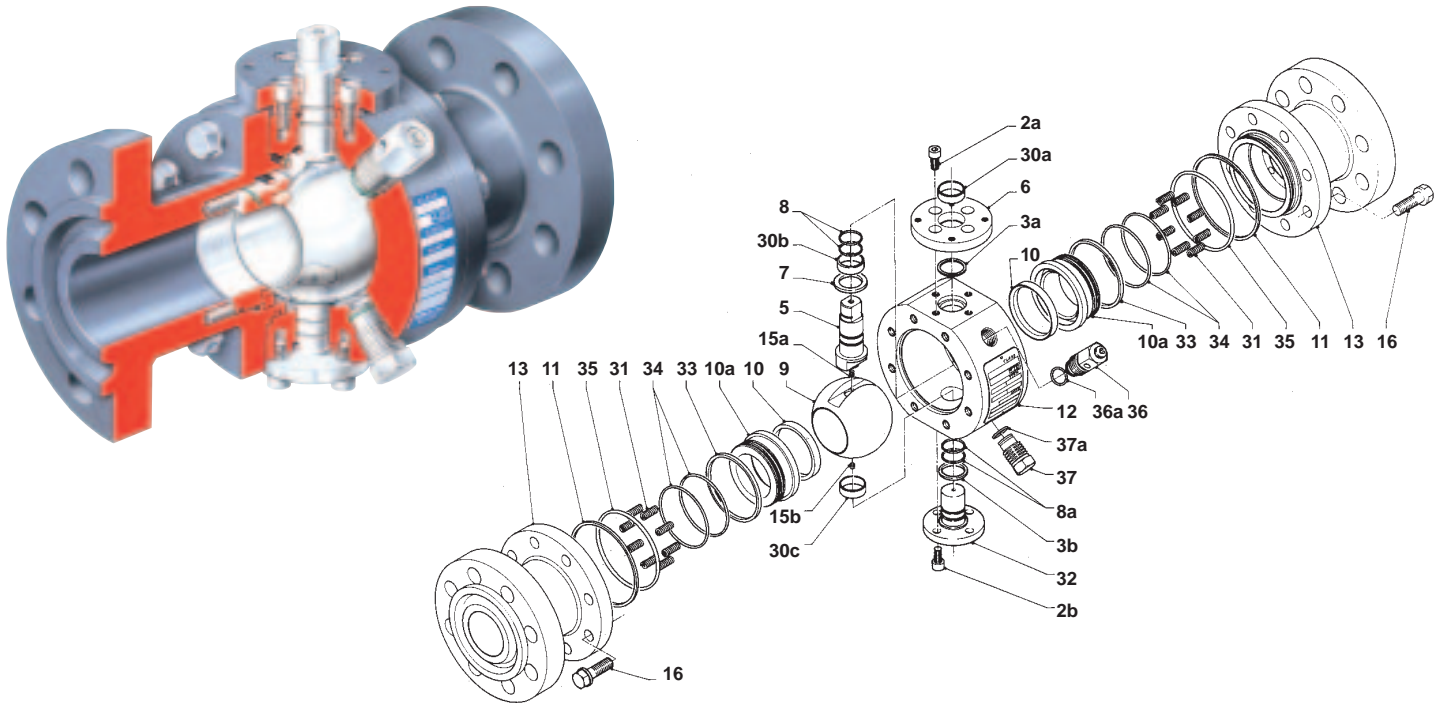

PART. No.	DESCRIPTION	STANDARD BASE MATERIAL					SPECIAL
		A105 / 316	LF2 / 316	316 / 316	F51 / F51	F44 / F44	
1	LEVER	C.S. Galvanized Plastic cover	C.S. Galvanized Plastic cover	C.S. Galvanized Plastic cover	C.S. Galvanized Plastic cover	C.S. Galvanized Plastic cover	
1a	LEVER BOLT	C.S. Zinc plated	C.S. Zinc plated	Stainless Steel	Stainless Steel	Stainless Steel	
2a	TOP COVER SCREW	ASTM A193 B8	ASTM A193 B8	ASTM A193 B8	ASTM A193 B8	ASTM A193 B8	
2b	TRUNNION RETAINER SCREW						
3a	STEM FIRE SEAL	Graphite	Graphite	Graphite	Graphite	Graphite	
3b	TRUNNION FIRE SEAL						
5	UPPER STEM	ASTM A276/479TP316	ASTM A276/479TP316	ASTM A276/479TP316	UNS S31803	UNS S31254	
6	TOP COVER	ASTM A105N	ASTM A350 LF2	ASTM A276/479TP316	UNS S31803	UNS S31254	
7	THRUST WASHER	Reinforced PTFE "S"	Reinforced PTFE "S"	Reinforced PTFE "S"	Reinforced PTFE "S"	Reinforced PTFE "S"	
8	STEM "O" RING	VITON	VITON	VITON	VITON	VITON	
8a	TRUNNION "O" RING						
9	BALL	ASTM A182 F316	ASTM A182 F316	ASTM A182 F316	UNS S31803	UNS S31254	
10	ISERT SEAT	T-R-S LOW PR. N-D-P-E HIGH PR.	T-R-S LOW PR. N-D-P-E HIGH PR.	T-R-S LOW PR. N-D-P-E HIGH PR.	T-R-S LOW PR. N-D-P-E HIGH PR.	T-R-S LOW PR. N-D-P-E HIGH PR.	
10a	SEAT RING	ASTM A276/479TP316	ASTM A276/479TP316	ASTM A276/479TP316	UNS S31803	UNS S31254	
11	ADAPTOR FIRE SEAL	Graphite	Graphite	Graphite	Graphite	Graphite	
12	BODY	ASTM A105N	ASTM A350 LF2	ASTM A182 F316	UNS S31803 ASTM A182 F51	UNS S31254 ASTM A182 F44	
13	ADAPTOR FLANGE	ASTM A105N	ASTM A350 LF2	ASTM A182 F316	UNS S31803 ASTM A182 F51	UNS S31254 ASTM A182 F44	
14	STOP PIN	Stainless Steel	Stainless Steel	Stainless Steel	Stainless Steel	Stainless Steel	
15a	ANTISTATIC SPRING	S.S. 316	S.S. 316	S.S. 316	S.S. 316	S.S. 316	
15b							
16	ADAPTOR BOLTS	ASTM A193 B7M	ASTM A320 L7M	ASTM A193 B8M	ASTM A193 B8M	ASTM A193 B8M	
17	STOP LEVER WASHER	Stainless Steel only for bigger size	Stainless Steel only for bigger size	Stainless Steel only for bigger size	Stainless Steel only for bigger size	Stainless Steel only for bigger size	
30a	UPPER STEM BEARING	DU-DRY	DU-DRY	DU-DRY	DU-DRY	DU-DRY	
30b	LOWER STEM BEARING						
30c	TRUNNION BEARING						
31	SEAT SPRINGS	INCONEL X-750	INCONEL X-750	INCONEL X-750	INCONEL X-750	INCONEL X-750	
32	TRUNNION	ASTM A276/479TP316	ASTM A276/479TP316	ASTM A276/479TP316	UNS S31803	UNS S31254	
33	SEAT FIRE SEAL	Graphite	Graphite	Graphite	Graphite	Graphite	
34	SEAT "O" RING	VITON	VITON	VITON	VITON	VITON	
35	ADAPTOR "O" RING	VITON	VITON	VITON	VITON	VITON	
36	VENT VALVE/BLEEDER	ASTM A276/479TP316	ASTM A276/479TP316	ASTM A276/479TP316	UNS S31803	UNS S31254	
36a	VENT "O" RING	VITON	VITON	VITON	VITON	VITON	
37	DRAIN PLUG	ASTM A276/479TP316	ASTM A276/479TP316	ASTM A276/479TP316	UNS S31803	UNS S31254	
37a	DRAIN "O" RING	VITON	VITON	VITON	VITON	VITON	
NP	NAME PLATE	Stainless Steel	Stainless Steel	Stainless Steel	Stainless Steel	Stainless Steel	

RECOMMENDED SPARE PARTS FOR START-UP OR COMMISSIONING



? CBGHFI ? 79 !'A5 H9F -â @

DESIGN FOR:
6" Full Bore
8" Reduced Bore

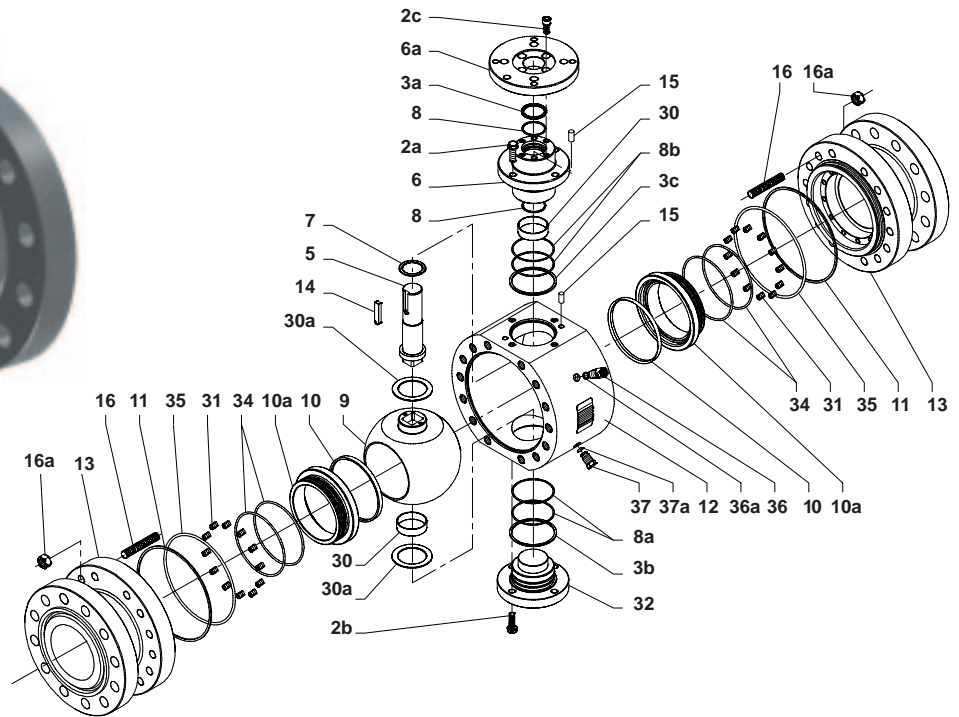
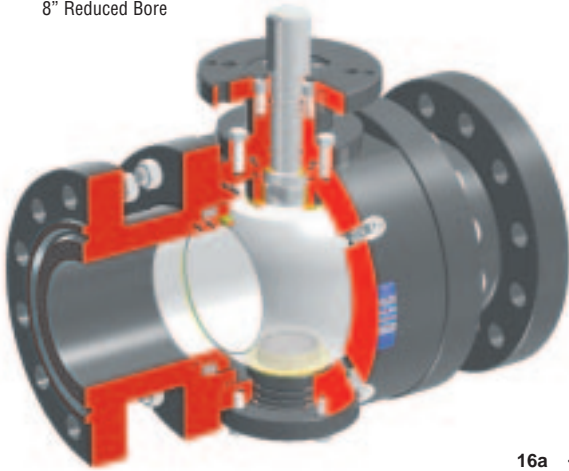

PART. No.	DESCRIPTION	STANDARD BASE MATERIAL					SPECIAL
		A105 / 316	LF2 / 316	316 / 316	F51 / F51	F44 / F44	
2a 2b 2c	TOP COVER SCREW TRUNNION RETAINER SCREW UPPER FLANGE SCREW	ASTM A193 B8	ASTM A193 B8	ASTM A193 B8	ASTM A193 B8	ASTM A193 B8	
3a 3b 3c	STEM FIRE SEAL TRUNNION FIRE SEAL TOP COVER FIRE SEAL	Graphite	Graphite	Graphite	Graphite	Graphite	
5	UPPER STEM	ASTM A276/479 TP316	ASTM A276/479 TP316	ASTM A276/479 TP316	UNS S31803	UNS S31254	
6	TOP COVER	ASTM A105N	ASTM A350 LF2	ASTM A276/479 TP316	UNS S31803	UNS S31254	
6a	UPPER FLANGE	ASTM A105N	ASTM A350 LF2	ASTM A276/479 TP316	UNS S31803	UNS S31254	
7	THRUST WASHER	DU-DRY	DU-DRY	DU-DRY	DU-DRY	DU-DRY	
8 8a 8b	STEM "O" RING TRUNNION "O" RING TOP COVER "O" RING	VITON	VITON	VITON	VITON	VITON	
9	BALL	ASTM A276/479 TP316	ASTM A276/479 TP316	ASTM A276/479 TP316	UNS S31803	UNS S31254	
10	ISERT SEAT	T-R-S LOW PR. N-D-P-E HIGH PR.	T-R-S LOW PR. N-D-P-E HIGH PR.	T-R-S LOW PR. N-D-P-E HIGH PR.	T-R-S LOW PR. N-D-P-E HIGH PR.	T-R-S LOW PR. N-D-P-E HIGH PR.	
10a	SEAT RING	ASTM A276/479 TP316	ASTM A276/479 TP316	ASTM A276/479 TP316	UNS S31803	UNS S31254	
11	ADAPTOR FIRE SEAL	Graphite	Graphite	Graphite	Graphite	Graphite	
12	BODY	ASTM A105N	ASTM A350LF2	ASTM A276/479 TP316	UNS S31803	UNS S31254	
13	ADAPTOR FLANGE	ASTM A105N	ASTM A350LF2	ASTM A276/479 TP316	UNS S31803	UNS S31254	
14	STEM KEY	Carbon Steel	Carbon Steel	Carbon Steel	Carbon Steel	Carbon Steel	
15	TOP COVER PIN	Carbon Steel	Carbon Steel	Carbon Steel	Carbon Steel	Carbon Steel	
16	STUD BOLTS	ASTM A193 B7M	ASTM A320 L7M	ASTM A193 B8M	ASTM A193 B8M	ASTM A193 B8M	
16a	NUTS	ASTM A194 2H-M	ASTM A194 GR 4	ASTM A194 GR 8M	ASTM A194 GR 8M	ASTM A194 GR 8M	
30 30a	BALL BEARING BEARING WASHER	DU-DRY	DU-DRY	DU-DRY	DU-DRY	DU-DRY	
31	SEAT SPRINGS	INCONEL X-750	INCONEL X-750	INCONEL X-750	INCONEL X-750	INCONEL X-750	
32	TRUNNION	ASTM A105N	ASTM A350 LF2	ASTM A276/479 TP316	UNS S31803	UNS S31254	
34	SEAT "O" RING	VITON	VITON	VITON	VITON	VITON	
35	ADAPTOR "O" RING	VITON	VITON	VITON	VITON	VITON	
36	VENT VALVE/BLEADER	ASTM A276/479 TP316	ASTM A276/479 TP316	ASTM A276/479 TP316	UNS S31803	UNS S31254	
36a	VENT "O" RING	VITON	VITON	VITON	VITON	VITON	
37	DRAIN PLUG	ASTM A276/479 TP316	ASTM A276/479 TP316	ASTM A276/479 TP316	UNS S31803	UNS S31254	
37a	DRAIN "O" RING	VITON	VITON	VITON	VITON	VITON	
NP	NAME PLATE	Stainless Steel	Stainless Steel	Stainless Steel	Stainless Steel	Stainless Steel	

RECOMMENDED SPARE PARTS FOR START-UP OR COMMISSIONING

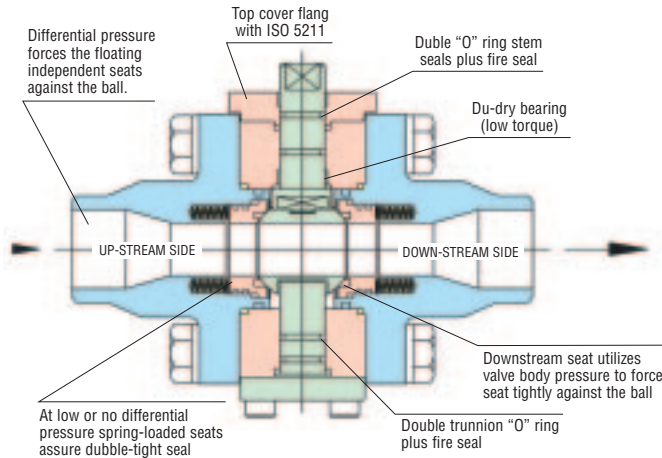

SELF AUTOMATIC RELIEVING SEATS



PISTON ACTION SEATS



CONSTRUCTION: THREE PIECES BOLTED CONSTRUCTION - SOLID BALL - ANTI BLOW OUT PROOF STEM DESIGN - DOUBLE SEAL SOFT INSERT SEATS AUTOMATIC RELIEVING IN CASE OF BODY OVER PRESSURING - DOUBLE BLOCK AND BLEED - HIGH INTEGRITY SHUT-OFF AT LOW AND HIGH PRESSURE - ANTISTATIC DEVICE - FIRE TEST APPROVED - FLOATING SEATS SPRING ENERGIZED - ISO 5211 TOP COVER FLANGE FOR EASY AUTOMATION.

SIZE: 1/4" TO 6" FULL BORE - 3/4" TO 8" REDUCED BORE

CLASS: ASME 150 ÷ 2500 LBS

TEMPERATURE: -200 °C UP TO +350 °C

MATERIAL: ASTM A 105 - LF2 - 316 - 316L - F44 - F51 AND SPECIAL MATERIALS NACE LAST EDITION

DESIGN: ASME B16.34 - BS5351 FOR 1.1/2" AND SMALLER SIZE / ASME B16.34 - API6D FOR 2" AND LARGER

FIRE TEST APPROVED: BS6755 PART 2, 1987 - API607 FOURTH EDITION, MAY 1993 - API6FA, MAY 1985 (REAFFIRMED MAY 1993)

MARKING: MSS SP25

TEST CERTIFICATE: UNI EN 10204 TYPE 3.1B UNLESS OTHER WISE REQUIRED

SERVICE: FOR PETROLEUM, CHEMICALS, PETROLCHEMICALS AND ALLIED INDUSTRIES

MANEUVRABILITY AND TORQUE AT MAXIMUM WORKING PRESSURE FOR DIFFERENT CLASS, SIZE AND MATERIAL AT ROOM TEMPERATURE IN CLEAN SERVICE USING WATER WITH 7% oil.
BT = BREAK AWAY TORQUE OT = OPERATING TORQUE RT = RESEATING TORQUE ALL VALUES ARE IN Nm NET VALUES

SIZE OF VALVE	FULL BORE RED. BORE	1/4" TO 1/2"			3/4"			1"			1.1/2"			2"			3"			4"			6"		
		BT	OT	RT	BT	OT	RT	BT	OT	RT	BT	OT	RT	BT	OT	RT	BT	OT	RT	BT	OT	RT	BT	OT	RT
CLASS 150 max. W.P. 19 BAR	S - R	9	6	8	14	10	12	18	14	16	45	30	35	55	40	50	105	70	85	160	110	140	365	300	340
	N - D	10	6	8	18	10	12	22	14	16	50	30	35	60	40	50	115	70	85	170	110	140	-	-	-
CLASS 300 max. W.P. 49,6 BAR	S - R	9	6	8	16	10	12	20	14	16	50	30	35	65	40	50	135	70	85	240	110	140	420	300	360
	N - D	10	6	8	20	10	12	24	14	16	55	30	35	70	40	50	145	70	85	250	110	140	-	-	-
CLASS 600 max. W.P. 99,3 BAR	S - R	14	6	8	18	10	12	22	14	16	70	30	35	75	40	50	170	70	85	320	110	140	650	300	450
	N - D	18	6	8	25	10	12	30	14	16	80	30	35	90	40	50	180	70	85	340	110	140	-	-	-
CLASS 800 max. W.P. 138 BAR	S - R	16	6	8	20	10	12	24	14	16	80	30	35	-	-	-	-	-	-	-	-	-	-	-	-
	N - D	22	6	8	27	10	12	31	14	16	95	30	35	110	40	50	250	70	85	440	180	230	-	-	-
CLASS 900 max. W.P. 149 BAR	S - R	18	8	10	22	10	12	26	16	18	-	-	-	-	-	-	-	-	-	-	-	-	-	-	-
	N - D	25	8	10	28	12	14	32	16	18	105	35	40	120	50	70	320	80	95	580	180	230	-	-	-
CLASS 1500 max. W.P. 248 BAR	S - R	-	-	-	-	-	-	-	-	-	-	-	-	-	-	-	-	-	-	-	-	-	-	-	-
	N - D	28	8	10	32	12	14	40	16	18	160	35	40	200	50	70	430	80	95	900	180	230	-	-	-
CLASS 2500 max. W.P. 414 BAR	S - R	-	-	-	-	-	-	-	-	-	-	-	-	-	-	-	-	-	-	-	-	-	-	-	-
	N - D	40	12	14	50	12	14	55	16	18	220	35	40	250	50	70	450	80	95	-	-	-	-	-	-

It must be understood that many factors can influence the torque of ball valves in field service. For this reason to SELECT PROPER ACTUATOR it must be used the "TORQUE ADJUSTMENT FACTORS" table no. A003/94

$$\text{NET BREAK AWAY TORQUE OF VALVES} \times \text{PROCESS MEDIA} \times \text{FREQUENCY OF OPERATION} \times \text{PROCESS TEMPERATURE} \times \text{VALVE SEATING MATERIAL} \times \text{SUGGESTED SAFETY FACTOR} = \text{TORQUE TO SELECT ACTUATOR OR GEAR IN Nm}$$

PURCHASING INFORMATIONS			HOW TO ORDER STARLINE TRUNNION MOUNTED BALL VALVES						EXAMPLE:
SIZE	CLASS	END CONNECTION	1 = PORT DESIGN	2 = TYPE OF VALVE	3 = BASE MATERIAL BODY/TRIM	4 = INSERT SEAT MATERIAL	5 = STEM/TRUNNION PACKING	6 = O'RINGS	
<p>Note: These three elements are not in code and must be clearly shown or all order.</p> <p>A complete valve specification requires the following information:</p> <ol style="list-style-type: none"> Size - Nominal pipe size and required valve bore, in accordance with API 6D. Working pressure. Type of end connections (if BW ends, specify the schedule of connecting pipe) Full description of actual service in respect of temperature, line fluid, presence of corrosion, etc. to allow a proper material selection. Any special feature, like stem extension, etc. Type of operator: manual, electric, pneumatic or hydraulic valve operators may be installed at Purchaser's option. <p>If a power operator is required, the following information shall be provided by Purchaser.</p> <ul style="list-style-type: none"> Maximum differential pressure during operation. Frequency of open-close operation. Desired time to open/close Power supply (voltage, ect., or line pressure for pneumatic or hydraulic actuators, ect.) Optional equipment required (manual emergency override, local/remote control, explosion proof enclosures, ect.). 			<p>1 = FULL BORE 2 = REDUCED BORE</p> <p>O= ULTRASTAR</p>	<p>1 = A105 / F6 2 = A105 / MONEL 3 = A105 / 316 4 = LF2 / F6 5 = LF2 / 316 6 = F316 / 316 7 = F316L / 316L 8 = MONEL / MONEL 9 = F51 / F51 0 = FOR ALL DIFFERENT MATERIAL</p>	<p>THERMOPLASTIC R Reinforced PTFE 15% Fiberglass S Reinforced PTFE 20% C. + 5% Gr. T Virgin PTFE N DEVLON-V® Polyamide-Nylon D DELRIN® Acetal resin K KELF PCTFE P PEEK® Polyether ketone E VESPEL SP 211 Polyimide U UHMWPE Polyethylene Z TEFZEL® ETFE (70G-25)</p>	<p>G Graphite T Virgin PTFE Parts no. 3a - 3b - 3c</p> <p>In order to maintain Fire safe requirements, stem/trunnion packings and fire seal (parts no. 3a - 3b - 3c and 11) are usually supplied in graphite.</p> <p>Stem/Trunnion packing material automatically indicate material of the fire seal.</p>	<p>V Viton B NBR</p> <p>O' rings: Stem- part no. 8 Trunnion - part no. 8a Top cover - part no. 8b Adaptor - part no. 35 Seat - part no. 34 Drain - part no. 37a Vent - part no. 36a</p>	<p>Valve size 2" Class 600 RTJ Full bore Body/Adaptor Flange A105 Trim = 316 Bolts = B7M Seat insert - Nylon (Devlon-V) Packing = Graphite O' ring = Viton 2" - 600 - RTJ 103 NGV</p>	
<p>STANDARD DOCUMENTATION</p> <ol style="list-style-type: none"> TECHNICAL DEPARTMENT <ul style="list-style-type: none"> 1.1 General arrangement drawing (Mapping) 1.2 Assembly, details, cross sectional drawing 1.3 General arrangement with actuator PROCUREMENT DEPARTMENT <ul style="list-style-type: none"> 2.1 Maintenance manual 3. QA CONTROL DEPARTMENT 3.1 Certificate of compliance with the order 3.2 Material certificates <p>TECHNICAL SPECIFICATIONS TESTING: According to API 6D. Third party at customer charge PROTECTION: Standard manufacturer CERTIFICATION:</p> <p>BODY UNI.EN 10204 TYPE 3.1B END FLANGE UNI.EN 10204 TYPE 3.1B BALL UNI.EN 10204 TYPE 3.1B STEM/TRUNNION UNI.EN 10204 TYPE 3.1B SEAT RING UNI.EN 10204 TYPE 3.1B</p>									



PRESSURE - TEMPERATURE RATINGS

ASME 16.34 OR B16.5 AT -20°F TO 100°F (-29 TO +38°C). MAX. WORKING PRESSURE - SHELL TEST - SEAT TEST

MATERIAL		PRESSURE (psig) by classes							
GROUP	ITEM	150	300	400	600	900	1500	2500	4500
1.1 A105 A350-LF2	Working Pressure	285	740	990	1480	2220	3705	6170	11110
	Shell Test	450	1125	1500	2225	3350	5575	9275	16675
	Seat Test	315	815	1090	1630	2445	4075	6790	12225
1.2, 1.7, 1.9, 1.10, 1.11, 1.13, 1.14 A350-LF3	Working Pressure	290	750	1000	1500	2250	3750	6250	11250
	Shell Test	450	1125	1500	2250	3375	5625	9375	16875
	Seat Test	320	825	1100	1650	2475	4125	6875	12375
1.3, 1.5 A182-F1	Working Pressure	265	695	925	1390	2085	3470	5785	10415
	Shell Test	400	1050	1400	2100	3150	5225	8700	15625
	Seat Test	295	765	1020	1530	2295	3820	6365	11460
1.4, 1.8, 1.12	Working Pressure	235	620	825	1235	1850	3085	5145	9260
	Shell Test	375	950	1250	1875	2775	4650	7725	13900
	Seat Test	260	685	910	1360	2035	3395	5660	10190
1.6	Working Pressure	225	590	785	1175	1760	2935	4895	8810
	Shell Test	350	900	1200	1775	2650	4425	7350	13225
	Seat Test	250	650	865	1295	1940	3230	5385	9695
2.1, 2.2, 2.4, 2.5 A182-F304 A182-F304H A182-F316 A182-F316H	Working Pressure	275	720	960	1440	2160	3600	6000	10800
	Shell Test	425	1100	1450	2175	3250	5400	9000	16200
	Seat Test	305	795	1060	1585	2380	3960	6600	11880

MATERIAL		PRESSURE (psig) by classes							
GROUP	ITEM	150	300	400	600	900	1500	2500	4500
2.3 A182-F304L A182-LF16L	Working Pressure	230	600	800	1200	1800	3000	5000	9000
	Shell Test	350	900	1200	1800	2700	4500	7500	13500
	Seat Test	255	660	880	1320	1980	3300	5500	9900
2.6, 2.7	Working Pressure	260	670	895	1345	2015	3360	5600	10080
	Shell Test	400	1025	1350	2025	3025	5050	8400	16200
	Seat Test	290	740	985	1480	2220	3700	6160	11880

NOTE: ① For working pressure ratings at other temperatures and material group refer to ASME B16.34 or B16.5.
 ② Shell hydrostatic test pressure is 1.5 times the 100 deg F rating rounded off to the next higher 25 psi.
 ③ High pressure seat hydrostatic test pressure is 1.1 times the 100 deg F rating rounded off to the next higher 5 psi.
 ④ All ratings are for "Standard Class" valves.

GROUP MATERIALS		PRODUCT FORMS		
MATERIAL GROUP No.	NOMINAL DESIGNATION STEEL	FORGINGS SPEC.-GR	CASTINGS SPEC.-GR	PLATES SPEC.-GR
1.1	Carbon	A105 A350-LF2	A216-WCB	A515-70 A516-70
	C-Mn Si			A537-C1.1
2.1	18 Cr - 8 Ni 18 Cr - 8 Ni	A182-F304 A182-F304H	A351-CF3 A351-CF8	A240-304 A240-304H A240-316 A240-316H
	16 Cr - 12 Ni - 2 Mo	A182-F316 A182-F316H		A240-317
2.2	18 Cr - 13 Ni - 3 Mo 18 Cr - 9 Ni - 2 Mo		A351-CF3M A351-CF8M	
				A240-304L A240-316L
2.3	18 Cr - 8Ni 16 Cr - 12 Ni - 2 Mo	A182-F304L A182-F316L		

PRESSURE/TEMPERATURE LIMITATIONS OF SOFT INSERT SEAT MATERIAL

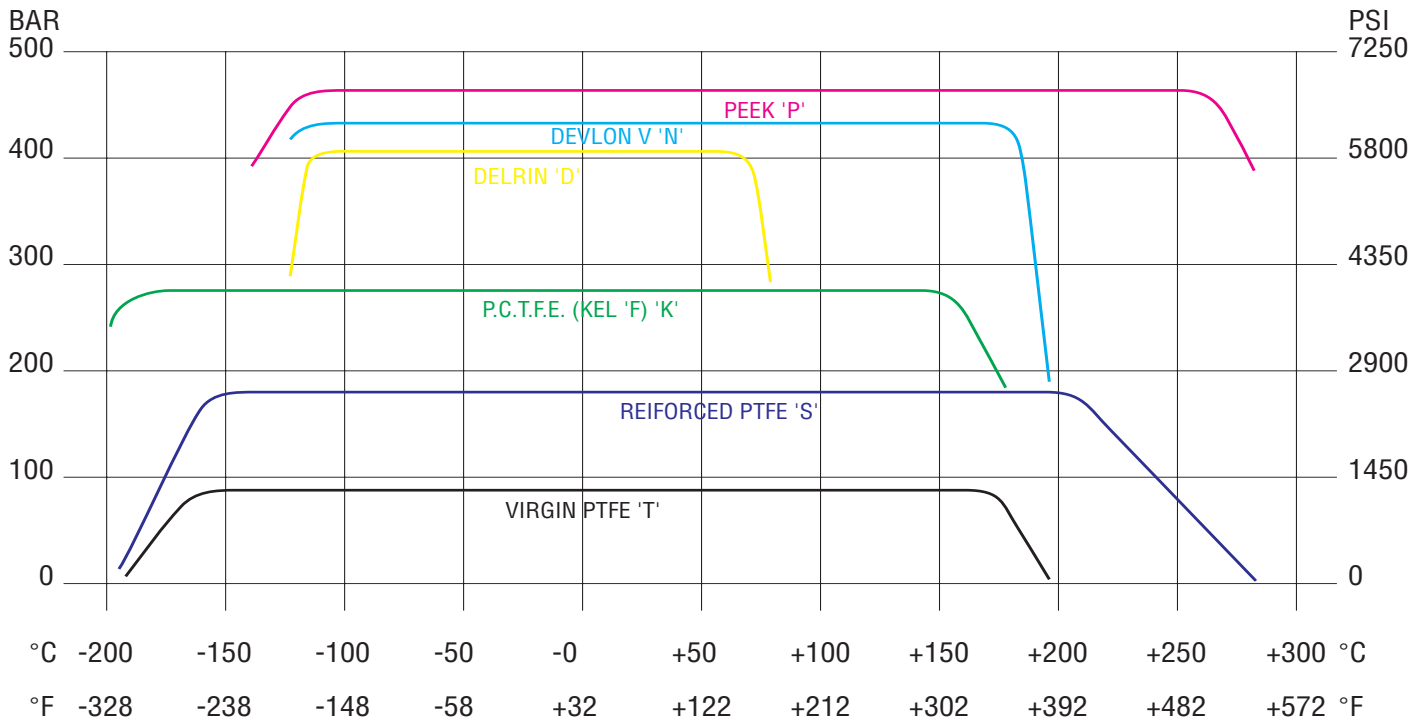

MAX. WORKING PRESSURE AND PRESSURE TEST OF VALVES

VALUES FROM API 6D - API 6A

MAXIMUM OPERATING PRESSURE	PRESSURE CLASS OF VALVE	ASME 150 PN 20	ASME 300 PN 50	ASME 400 PN 68	ASME 600 PN 100	ASME 800 (*)	ASME 900 PN 150	ASME 1500 PN 250	ASME 2500 PN 420	API 2000	API 3000	API 5000	API 10000	For temperatures below -20°F or -29°C the rating shall be no greater than the rating shown for -20°F or -29°C.
-29 to 38°C -20 to 100°C		19	49.6	66.2	99.3	138	149	248	414	138	207	345	690	
		275	720	960	1440	2000	2160	3600	6000	13800	3000	5000	10000	
		1900	4960	6620	9930	13800	14900	24800	41400			34500	69000	

PRESSURE TEST ①	HYDROSTATIC SHELL TEST	Bar	29	76	100	150	207	224	372	621	276	414	690	1035	DURATION TEST	
															VALVE SIZE	MINUTES A
		Psig	425	1100	1450	2175	3000	3250	5400	9000	4000	6000	10000	15000	2" thru 4"	2
		Kpa	2900	7600	10000	15000	20700	22400	37200	62100	27600	41400	69000	103500	6" thru 10"	5
	HYDROSTATIC SEATS TEST	Bar	21	55	73	110	152	166	276	455	152	228	630	760	2" thru 4"	2
		Psig	300	800	1060	1600	2204	2400	4000	6600	2204	3306	9135	11020	6" thru 10"	5
	AIR SEATS TEST	Bar±1	6	6	6	6	6	6	6	6	6	6	6	6	2" thru 4"	2
		Psig±10	80	80	80	80	80	80	80	80	80	80	80	80	6 and over	5



FCNA FCJâ 'H 85 '7 @ GG'9 \$

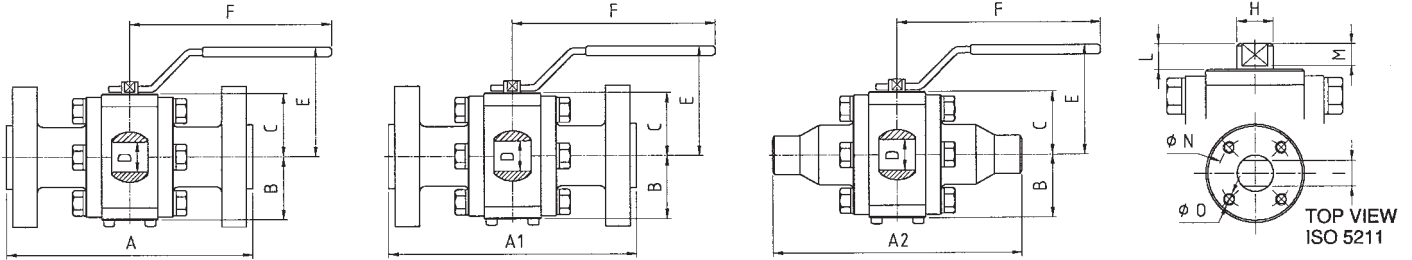

GEAR OPERATED

VALVE SIZE		DIMENSIONS in mm									WEIGHT KG		
INCH	mm	A	A1	A2	B	C	D	E	F	RF	RTJ	BW	
1/2" x 1/2"	15 x 15	140	152	165	40	40	12.7	95	193	3.5	4	3	
3/4" x 3/4"	20 x 20	152	165	191	48	48	19	110	225	6	6.5	6	
1" x 1"	25 x 25	165	178	216	61	61	25.4	115	225	8.5	9.5	9	
1.1/4" x 1.1/4"	32 x 32	-	-	-	-	-	-	-	-	-	-	-	
1.1/2" x 1.1/2"	40 x 40	191	203	241	75	72	38	145	365	14	15	12.5	
2" x 2"	50 x 50	216	232	292	88	88	51	160	365	21	25	22	
3" x 3"	80 x 80	283	298	356	120	120	76	195	470	55	57	48	
4" x 4"	100 x 100	305	320.5	432	160	160	101.6	-	-	105	108	110	
6" x 6"	150 x 150	394	406.5	559	191	249	152	-	-	180	185	210	

FTO F TO ASME ANSI CLASS 150 AVAILABLE ON REQUEST

MANUAL GEAR OPERATION OR AUTOMATION

DIMENSIONS in mm							ISO
H	I	L	M	N	O		5211
12	7.5	6.5	6.5	42	M5		F04
15	9	8.5	7.5	50	M6		F05
15	9	10	9	50	M6		F05
-	-	-	-	-	-	-	-
22	16	19	16	70	M8		F07
22	16	19	16	70	M8		F07
24	18	24	22	70	M8		F07
40	30	32	29	102	M10		F10
48	KEY 14	68	66	140	ø 18		F14

VALVE SIZE		DIMENSIONS in mm									WEIGHT KG		
INCH	mm	A	A1	A2	B	C	D	E	F	RF	RTJ	BW	
3/4" x 1/2"	20 x 15	152	165	191	40	40	12.7	95	193	5	5.5	3.5	
1" x 3/4"	25 x 20	165	178	216	48	48	19	110	225	6.5	7	6.5	
1.1/4" x 1"	32 x 25	178	191	229	61	61	25.4	115	225	10	11	9.5	
1.1/2" x 1"	40 x 25	191	203	241	61	61	25.4	115	225	12	13	9.5	
2" x 1.1/2"	50 x 40	216	232	292	75	72	38	145	365	20	21	13.5	
3" x 2"	80 x 80	283	298	356	88	88	51	160	365	30	32	24	
4" x 3"	100 x 80	305	320.5	432	120	120	76	195	470	75	78	55	
6" x 4"	150 x 100	403	419	559	160	160	101.6	-	-	115	118	112	
8" x 6"	200 x 150	457	470	660.5	191	249	152	-	-	195	198	220	

FTO F TO ASME ANSI CLASS 150 AVAILABLE ON REQUEST

MANUAL GEAR OPERATION OR AUTOMATION

DIMENSIONS in mm							ISO
H	I	L	M	N	O		5211
12	7.5	6.5	6.5	42	M5		F04
15	9	8.5	7.5	50	M6		F05
15	9	10	9	50	M6		F05
15	9	10	9	50	M6		F05
22	16	19	16	70	M8		F07
22	16	19	16	70	M8		F07
24	18	24	22	70	M8		F07
40	30	32	29	102	M10		F10
48	KEY 14	68	66	140	ø 18		F14

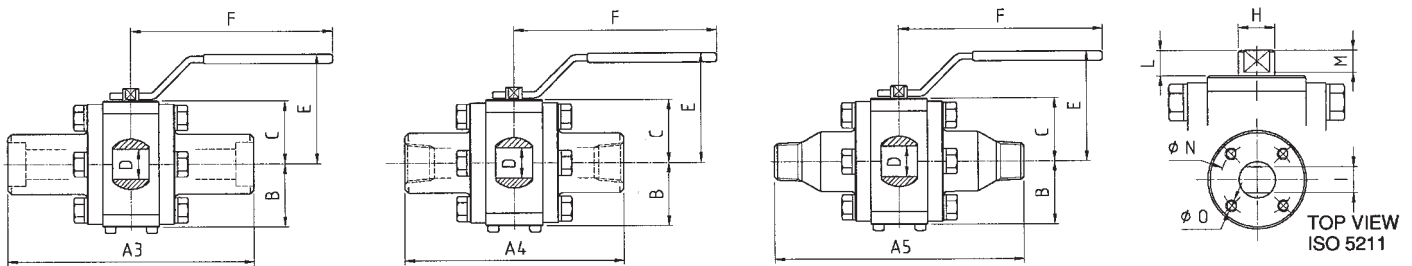

VALVE SIZE		DIMENSIONS in mm									WEIGHT KG		
INCH	mm	A3	A4	A5	B	C	D	E	F	SW	THREADED		
											FEMALE	MALE	
1/2" x 1/2"	15 x 15	165	130	165	40	40	12.7	95	193	3	2.5	3	
3/4" x 3/4"	20 x 20	191	145	191	48	48	19	110	225	6	5.5	6	
1" x 1"	25 x 25	216	170	216	61	61	25.4	115	225	9	8.5	9	
1.1/4" x 1.1/4"	32 x 32	-	-	-	-	-	-	-	-	-	-	-	
1.1/2" x 1.1/2"	40 x 40	241	210	241	75	72	38	145	365	12.5	12	12.5	
2" x 2"	50 x 50	292	230	292	88	88	51	160	365	22	21	22	
3" x 3"	80 x 80	356	-	-	120	120	76	195	470	48	-	-	
4" x 4"	100 x 100	432	-	-	160	160	101.6	-	-	110	-	-	
6" x 6"	150 x 150	559	-	-	191	249	152	-	-	215	-	-	

MANUAL GEAR OPERATION OR AUTOMATION

DIMENSIONS in mm							ISO
H	I	L	M	N	O		5211
12	7.5	6.5	6.5	42	M5		F04
15	9	8.5	7.5	50	M6		F05
15	9	10	9	50	M6		F05
-	-	-	-	-	-	-	-
22	16	19	16	70	M8		F07
22	16	19	16	70	M8		F07
24	18	24	22	70	M8		F07
40	30	32	29	102	M10		F10
48	KEY 14	68	66	140	ø 18		F14

VALVE SIZE		DIMENSIONS in mm									WEIGHT KG		
INCH	mm	A3	A4	A5	B	C	D	E	F	SW	THREADED		
											FEMALE	MALE	
3/4" x 1/2"	20 x 15	191	130	191	40	40	12.7	95	193	3.5	2.5	3.5	
1" x 3/4"	25 x 20	216	145	216	48	48	19	110	225	6.5	5.5	6.5	
1.1/4" x 1"	32 x 25	229	170	229	61	61	25.4	115	225	9.5	8.5	9.5	
1.1/2" x 1"	40 x 25	241	170	241	61	61	25.4	115	225	9.5	8.5	9.5	
2" x 1.1/2"	50 x 40	292	210	292	75	72	38	145	365	13.5	12	13.5	
3" x 2"	80 x 80	356	-	-	88	88	51	160	365	24	-	-	
4" x 3"	100 x 80	432	-	-	120	120	76	195	470	55	-	-	
6" x 4"	150 x 100	559	-	-	160	160	101.6	-	-	112	-	-	
8" x 6"	200 x 150	660.5	-	-	191	249	152	-	-	225	-	-	

MANUAL GEAR OPERATION OR AUTOMATION

DIMENSIONS in mm							ISO
H	I	L	M	N	O		5211
12	7.5	6.5	6.5	42	M5		F04
15	9	8.5	7.5	50	M6		F05
15	9	10	9	50	M6		F05
15	9	10	9	50	M6		F05
22	16	19	16	70	M8		F07
22	16	19	16	70	M8		F07
24	18	24	22	70	M8		F07
40	30	32	29	102	M10		F10
48	KEY 14	68	66	140	ø 18		F14



FCNA FCJâ 'H Æ5 '7 @ GG' \$\$

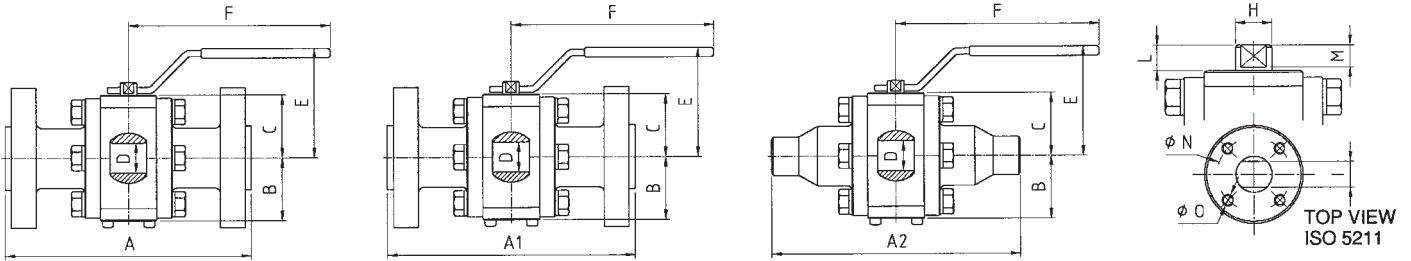

GEAR OPERATED

VALVE SIZE		DIMENSIONS in mm								WEIGHT KG		
INCH	mm	A	A1	A2	B	C	D	E	F	RF	RTJ	BW
1/2" x 1/2"	15 x 15	140	152	165	40	40	12.7	95	193	4	4.5	3
3/4" x 3/4"	20 x 20	152	165	191	48	48	19	110	225	6.5	7	6
1" x 1"	25 x 25	165	178	216	61	61	25.4	115	225	9	10	9
1.1/4" x 1.1/4"	32 x 32	-	-	-	-	-	-	-	-	-	-	-
1.1/2" x 1.1/2"	40 x 40	191	203	241	75	72	38	145	365	15	16	12.5
2" x 2"	50 x 50	216	232	292	88	88	51	160	365	22	26	22
3" x 3"	80 x 80	283	298	356	120	120	76	195	470	57	60	48
4" x 4"	100 x 100	305	320.5	432	160	160	101.6	-	-	110	112	110
6" x 6"	150 x 150	403	419	559	191	249	152	-	-	205	210	210

DIMENSIONS in mm							ISO
H	I	L	M	N	O		5211
12	7.5	6.5	6.5	42	M5		F04
15	9	8.5	7.5	50	M6		F05
15	9	10	9	50	M6		F05
-	-	-	-	-	-		-
22	16	19	16	70	M8		F07
22	16	19	16	70	M8		F07
24	18	24	22	70	M8		F07
40	30	32	29	102	M10		F10
48	KEY 14	68	66	140	ø 18		F14

VALVE SIZE		DIMENSIONS in mm								WEIGHT KG		
INCH	mm	A	A1	A2	B	C	D	E	F	RF	RTJ	BW
3/4" x 1/2"	20 x 15	152	165	191	40	40	12.7	95	193	5.5	6	3.5
1" x 3/4"	25 x 20	165	178	216	48	48	19	110	225	7	7.5	6.5
1.1/4" x 1"	32 x 25	178	191	229	61	61	25.4	115	225	11	12	9.5
1.1/2" x 1"	40 x 25	191	203	241	61	61	25.4	115	225	13	14	9.5
2" x 1.1/2"	50 x 40	216	232	292	75	72	38	145	365	21	22	13.5
3" x 2"	80 x 50	283	298	356	88	88	51	160	365	32	34	24
4" x 3"	100 x 80	305	320.5	432	120	120	76	195	470	78	82	55
6" x 4"	150 x 100	403	419	559	160	160	101.6	-	-	120	124	112
8" x 6"	200 x 150	502	518	660.5	191	249	152	-	-	230	238	220

DIMENSIONS in mm							ISO
H	I	L	M	N	O		5211
12	7.5	6.5	6.5	42	M5		F04
15	9	8.5	7.5	50	M6		F05
15	9	10	9	50	M6		F05
15	9	10	9	50	M6		F05
22	16	19	16	70	M8		F07
22	16	19	16	70	M8		F07
24	18	24	22	70	M8		F07
40	30	32	29	102	M10		F10
48	KEY 14	68	66	140	ø 18		F14

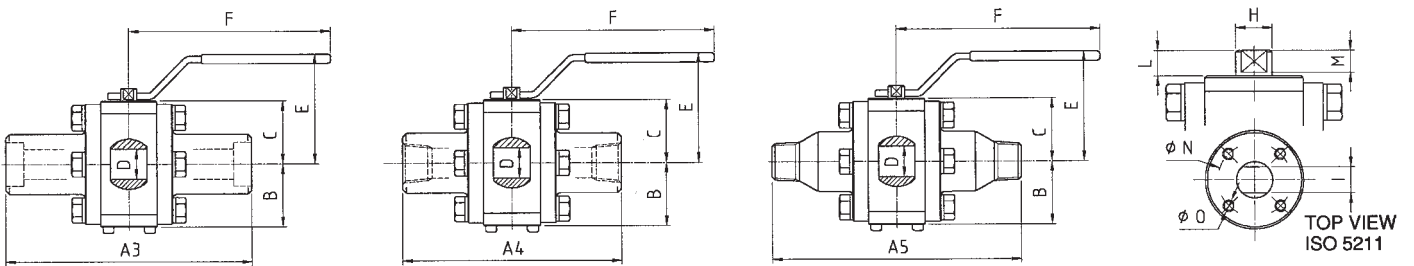

VALVE SIZE		DIMENSIONS in mm								WEIGHT KG		
INCH	mm	A3	A4	A5	B	C	D	E	F	SW	THREADED FEMALE	THREADED MALE
1/2" x 1/2"	15 x 15	165	130	165	40	40	12.7	95	193	3	2.5	3
3/4" x 3/4"	20 x 20	191	145	191	48	48	19	110	225	6	5.5	6
1" x 1"	25 x 25	216	170	216	61	61	25.4	115	225	9	8.5	9
1.1/4" x 1.1/4"	32 x 32	-	-	-	-	-	-	-	-	-	-	-
1.1/2" x 1.1/2"	40 x 40	241	210	241	75	72	38	145	365	12.5	12	12.5
2" x 2"	50 x 50	292	230	292	88	88	51	160	365	22	21	22
3" x 3"	80 x 80	356	-	-	120	120	76	195	470	48	-	-
4" x 4"	100 x 100	432	-	-	160	160	101.6	-	-	98	-	-
6" x 6"	150 x 150	559	-	-	191	249	152	-	-	215	-	-

DIMENSIONS in mm							ISO
H	I	L	M	N	O		5211
12	7.5	6.5	6.5	42	M5		F04
15	9	8.5	7.5	50	M6		F05
15	9	10	9	50	M6		F05
-	-	-	-	-	-		-
22	16	19	16	70	M8		F07
22	16	19	16	70	M8		F07
24	18	24	22	70	M8		F07
40	30	32	29	102	M10		F10
48	KEY 14	68	66	140	ø 18		F14

VALVE SIZE		DIMENSIONS in mm								WEIGHT KG		
INCH	mm	A3	A4	A5	B	C	D	E	F	SW	THREADED FEMALE	THREADED MALE
3/4" x 1/2"	20 x 15	191	130	191	40	40	12.7	95	193	3.5	2.5	3.5
1" x 3/4"	25 x 20	216	145	216	48	48	19	110	225	6.5	5.5	6.5
1.1/4" x 1"	32 x 25	229	170	229	61	61	25.4	115	225	9.5	8.5	9.5
1.1/2" x 1"	40 x 25	241	170	241	61	61	25.4	115	225	9.5	8.5	9.5
2" x 1.1/2"	50 x 40	292	210	292	75	72	38	145	365	13.5	12	13.5
3" x 2"	80 x 50	356	-	-	88	88	51	160	365	24	-	-
4" x 3"	100 x 80	432	-	-	120	120	76	195	470	55	-	-
6" x 4"	150 x 100	559	-	-	160	160	101.6	-	-	100	-	-
8" x 6"	200 x 150	660.5	-	-	191	249	152	-	-	225	-	-

DIMENSIONS in mm							ISO
H	I	L	M	N	O		5211
12	7.5	6.5	6.5	42	M5		F04
15	9	8.5	7.5	50	M6		F05
15	9	10	9	50	M6		F05
15	9	10	9	50	M6		F05
22	16	19	16	70	M8		F07
22	16	19	16	70	M8		F07
24	18	24	22	70	M8		F07
40	30	32	29	102	M10		F10
48	KEY 14	68	66	140	ø 18		F14



FCNA FCJâ 'H Æ5 '7 @ GG* \$\$

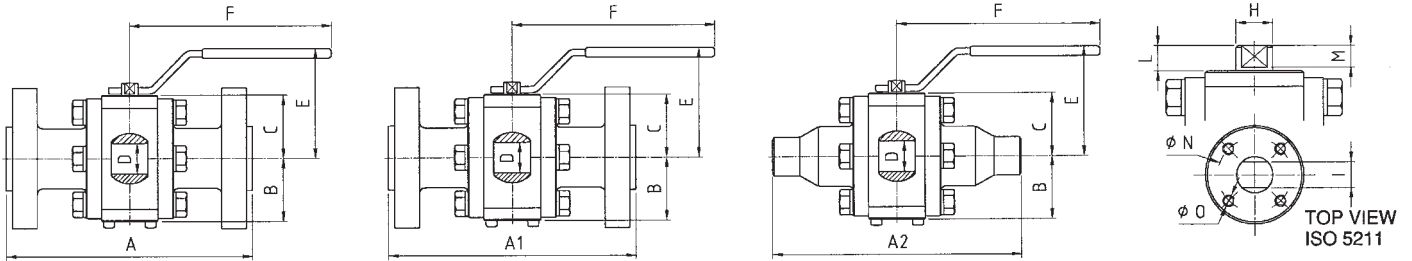

GEAR OPERATED

VALVE SIZE		DIMENSIONS in mm								WEIGHT KG		
INCH	mm	A	A1	A2	B	C	D	E	F	RF	RTJ	BW
1/2" x 1/2"	15 x 15	165	163.5	165	40	40	12.7	95	193	4.5	4.5	3
3/4" x 3/4"	20 x 20	191	191	191	48	48	19	110	225	7	7	6
1" x 1"	25 x 25	216	216	216	61	61	25.4	115	225	10	10	9
1.1/4" x 1.1/4"	32 x 32	-	-	-	-	-	-	-	-	-	-	-
1.1/2" x 1.1/2"	40 x 40	241	241	241	75	72	38	145	365	16	16	12.5
2" x 2"	50 x 50	292	295	292	88	88	51	160	365	26	26.5	22
3" x 3"	80 x 80	356	359	356	120	120	76	195	470	53	54	48
4" x 4"	100 x 100	432	435	432	160	160	101.6	-	-	120	122	110
6" x 6"	150 x 150	559	562	559	191	249	152	-	-	255	258	210

DIMENSIONS in mm							ISO
H	I	L	M	N	O		5211
12	7.5	6.5	6.5	42	M5		F04
15	9	8.5	7.5	50	M6		F05
15	9	10	9	50	M6		F05
-	-	-	-	-	-		-
22	16	19	16	70	M8		F07
22	16	19	16	70	M8		F07
24	18	24	22	70	M8		F07
40	30	32	29	102	M10		F10
48	KEY 14	68	66	140	ø 18		F14

VALVE SIZE		DIMENSIONS in mm								WEIGHT KG		
INCH	mm	A	A1	A2	B	C	D	E	F	RF	RTJ	BW
3/4" x 1/2"	20 x 15	191	191	191	40	40	12.7	95	193	5.5	5.5	3.5
1" x 3/4"	25 x 20	216	216	216	48	48	19	110	225	8	8	6.5
1.1/4" x 1"	32 x 25	229	229	229	61	61	25.4	115	225	12	12	9.5
1.1/2" x 1"	40 x 25	241	241	241	61	61	25.4	115	225	15	15	9.5
2" x 1.1/2"	50 x 40	292	295	292	75	72	38	145	365	25	25.5	13.5
3" x 2"	80 x 50	356	359	356	88	88	51	160	365	35	36	24
4" x 3"	100 x 80	436	435	432	120	120	76	195	470	65	67	55
6" x 4"	150 x 100	559	562	559	160	160	101.6	-	-	160	165	112
8" x 6"	200 x 150	660.5	664	660.5	191	249	152	-	-	290	298	220

DIMENSIONS in mm							ISO
H	I	L	M	N	O		5211
12	7.5	6.5	6.5	42	M5		F04
15	9	8.5	7.5	50	M6		F05
15	9	10	9	50	M6		F05
15	9	10	9	50	M6		F05
22	16	19	16	70	M8		F07
22	16	19	16	70	M8		F07
24	18	24	22	70	M8		F07
40	30	32	29	102	M10		F10
48	KEY 14	68	66	140	ø 18		F14

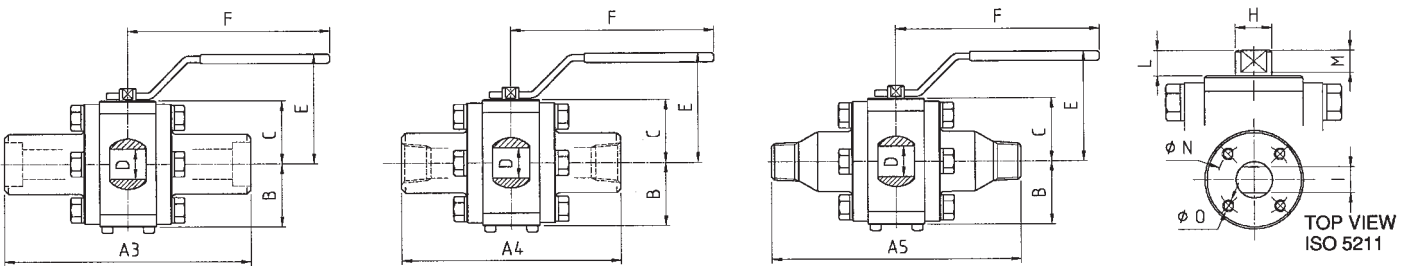

VALVE SIZE		DIMENSIONS in mm								WEIGHT KG		
INCH	mm	A3	A4	A5	B	C	D	E	F	SW	THREADED	
											FEMALE	MALE
1/2" x 1/2"	15 x 15	165	130	165	40	40	12.7	95	193	3	2.5	3
3/4" x 3/4"	20 x 20	191	145	191	48	48	19	110	225	6	5.5	6
1" x 1"	25 x 25	216	170	216	61	61	25.4	115	225	9	8.5	9
1.1/4" x 1.1/4"	32 x 32	-	-	-	-	-	-	-	-	-	-	-
1.1/2" x 1.1/2"	40 x 40	241	210	241	75	72	38	145	365	12.5	12	12.5
2" x 2"	50 x 50	292	230	292	88	88	51	160	365	22	21	22
3" x 3"	80 x 80	356	-	-	120	120	76	195	470	48	-	-
4" x 4"	100 x 100	432	-	-	160	160	101.6	-	-	110	-	-
6" x 6"	150 x 150	559	-	-	191	249	152	-	-	215	-	-

DIMENSIONS in mm							ISO
H	I	L	M	N	O		5211
12	7.5	6.5	6.5	42	M5		F04
15	9	8.5	7.5	50	M6		F05
15	9	10	9	50	M6		F05
-	-	-	-	-	-		-
22	16	19	16	70	M8		F07
22	16	19	16	70	M8		F07
24	18	24	22	70	M8		F07
40	30	32	29	102	M10		F10
48	KEY 14	68	66	140	ø 18		F14

VALVE SIZE		DIMENSIONS in mm								WEIGHT KG		
INCH	mm	A3	A4	A5	B	C	D	E	F	SW	THREADED	
											FEMALE	MALE
3/4" x 1/2"	20 x 15	191	130	191	40	40	12.7	95	193	3.5	2.5	3.5
1" x 3/4"	25 x 20	216	145	216	48	48	19	110	225	6.5	5.5	6.5
1.1/4" x 1"	32 x 25	229	170	229	61	61	25.4	115	225	9.5	8.5	9.5
1.1/2" x 1"	40 x 25	241	170	241	61	61	25.4	115	225	9.5	8.5	9.5
2" x 1.1/2"	50 x 40	292	210	292	75	72	38	145	365	13.5	12	13.5
3" x 2"	80 x 50	356	-	-	88	88	51	160	365	24	-	-
4" x 3"	100 x 80	432	-	-	120	120	76	195	470	55	-	-
6" x 4"	150 x 100	559	-	-	160	160	101.6	-	-	112	-	-
8" x 6"	200 x 150	660.5	-	-	191	249	152	-	-	225	-	-

DIMENSIONS in mm							ISO
H	I	L	M	N	O		5211
12	7.5	6.5	6.5	42	M5		F04
15	9	8.5	7.5	50	M6		F05
15	9	10	9	50	M6		F05
15	9	10	9	50	M6		F05
22	16	19	16	70	M8		F07
22	16	19	16	70	M8		F07
24	18	24	22	70	M8		F07
40	30	32	29	102	M10		F10
48	KEY 14	68	66	140	ø 18		F14



FCNA FCJâ 'H Æ5 '7 @ GG', \$\$

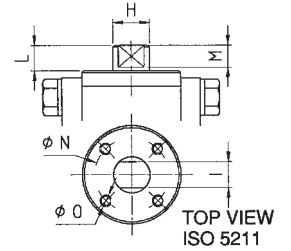
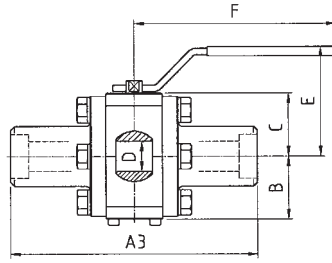
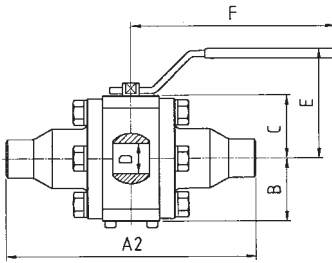

GEAR OPERATED

VALVE SIZE		DIMENSIONS in mm							WEIGHT KG	
INCH	mm	A3	A2	B	C	D	E	F	SW	BW
1/2" x 1/2"	15 x 15	165	165	40	40	12.7	95	193	3	3
3/4" x 3/4"	20 x 20	191	191	48	48	19	110	225	6	6
1" x 1"	25 x 25	216	216	61	61	25.4	115	225	9	9
1.1/4" x 1.1/4"	32 x 32	-	-	-	-	-	-	-	-	-
1.1/2" x 1.1/2"	40 x 40	241	241	75	72	38	145	365	12.5	12.5
2" x 2"	50 x 50	292	292	88	88	51	160	365	22	22
3" x 3"	80 x 80	356	356	120	120	76	195	470	48	48
4" x 4"	100 x 100	432	432	160	160	101.6	-	-	110	110
6" x 6"	150 x 150	559	559	191	249	152	-	-	215	210

DIMENSIONS in mm							ISO
H	I	L	M	N	O		5211
12	7.5	6.5	6.5	42	M5		F04
15	9	8.5	7.5	50	M6		F05
15	9	10	9	50	M6		F05
-	-	-	-	-	-		-
22	16	19	16	70	M8		F07
22	16	19	16	70	M8		F07
24	18	24	22	70	M8		F07
40	30	32	29	102	M10		F10
48	KEY 14	68	66	140	ø 18		F14

VALVE SIZE		DIMENSIONS in mm							WEIGHT KG	
INCH	mm	A3	A2	B	C	D	E	F	SW	BW
3/4" x 1/2"	20 x 15	191	191	40	40	12.7	95	193	3.5	3.5
1" x 3/4"	25 x 20	216	216	48	48	19	110	225	6.5	6.5
1.1/4" x 1"	32 x 25	229	229	61	61	25.4	115	225	9.5	9.5
1.1/2" x 1"	40 x 25	241	241	61	61	25.4	115	225	9.5	9.5
2" x 1.1/2"	50 x 40	292	292	75	72	38	145	365	13.5	13.5
3" x 2"	80 x 50	356	356	88	88	51	160	365	24	24
4" x 3"	100 x 80	432	432	120	120	76	195	470	55	55
6" x 4"	150 x 100	559	559	160	160	101.6	-	-	112	112
8" x 6"	200 x 150	660.5	660.5	191	249	152	-	-	225	220

DIMENSIONS in mm							ISO
H	I	L	M	N	O		5211
12	7.5	6.5	6.5	42	M5		F04
15	9	8.5	7.5	50	M6		F05
15	9	10	9	50	M6		F05
15	9	10	9	50	M6		F05
22	16	19	16	70	M8		F07
22	16	19	16	70	M8		F07
24	18	24	22	70	M8		F07
40	30	32	29	102	M10		F10
48	KEY 14	68	66	140	ø 18		F14

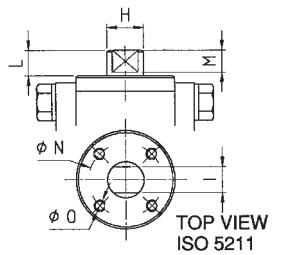
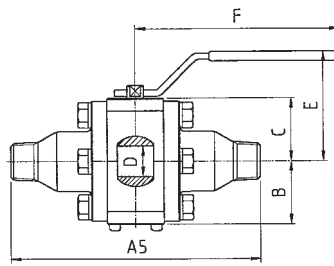
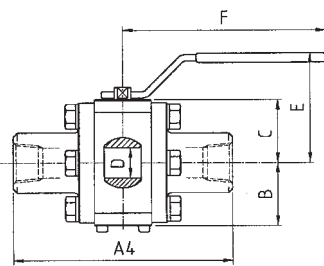

VALVE SIZE		DIMENSIONS in mm							WEIGHT KG	
INCH	mm	A4	A5	B	C	D	E	F	THREADED	
									FEMALE	MALE
1/2" x 1/2"	15 x 15	130	165	40	40	12.7	95	193	2.5	3
3/4" x 3/4"	20 x 20	145	191	48	48	19	110	225	5.5	6
1" x 1"	25 x 25	170	216	61	61	25.4	115	225	8.5	9
1.1/4" x 1.1/4"	32 x 32	-	-	-	-	-	-	-	-	-
1.1/2" x 1.1/2"	40 x 40	210	241	75	72	38	145	365	12	12.5
2" x 2"	50 x 50	230	292	88	88	51	160	365	21	22

DIMENSIONS in mm							ISO
H	I	L	M	N	O		5211
12	7.5	6.5	6.5	42	M5		F04
15	9	8.5	7.5	50	M6		F05
15	9	10	9	50	M6		F05
-	-	-	-	-	-		-
22	16	19	16	70	M8		F07
22	16	19	16	70	M8		F07

VALVE SIZE		DIMENSIONS in mm							WEIGHT KG	
INCH	mm	A4	A5	B	C	D	E	F	THREADED	
									FEMALE	MALE
3/4" x 1/2"	20 x 15	130	191	40	40	12.7	95	193	2.5	3.5
1" x 3/4"	25 x 20	145	216	48	48	19	110	225	5.5	6.5
1.1/4" x 1"	32 x 25	170	229	61	61	25.4	115	225	8.5	9.5
1.1/2" x 1"	40 x 25	170	241	61	61	25.4	115	225	8.5	9.5
2" x 1.1/2"	50 x 40	210	292	75	72	38	145	365	12	13.5

DIMENSIONS in mm							ISO
H	I	L	M	N	O		5211
12	7.5	6.5	6.5	42	M5		F04
15	9	8.5	7.5	50	M6		F05
15	9	10	9	50	M6		F05
15	9	10	9	50	M6		F05
22	16	19	16	70	M8		F07



FCNA FCJâ 'H Æ5 '7 @ GG- \$\$

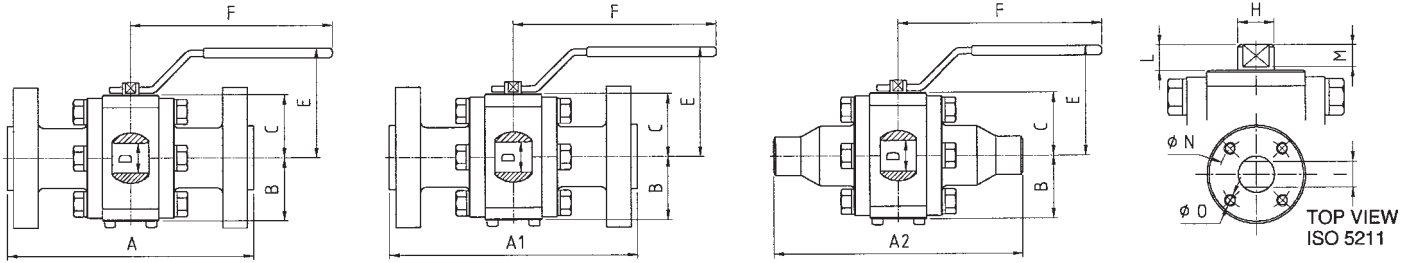

GEAR OPERATED

VALVE SIZE		DIMENSIONS in mm									WEIGHT KG		
INCH	mm	A	A1	A2	B	C	D	E	F	RF	RTJ	BW	
1/2" x 1/2"	15 x 15	216	216	216	40	40	12.7	95	193	5	5	3.5	
3/4" x 3/4"	20 x 20	229	229	229	48	48	19	110	225	11	11	9.5	
1" x 1"	25 x 25	254	254	254	61	61	25.4	115	225	18	18	15	
1.1/4" x 1.1/4"	32 x 32	-	-	-	-	-	-	-	-	-	-	-	
1.1/2" x 1.1/2"	40 x 40	305	305	305	85	90	38	155	365	34	34	30	
2" x 2"	50 x 50	368	371	368	102	100	51	175	470	50	50	45	
3" x 3"	80 x 80	381	384	381	150	148	76	-	-	85	86	50	
4" x 4"	100 x 100	457	460	457	188	188	101.6	-	-	170	175	150	

DIMENSIONS in mm							ISO 5211
H	I	L	M	N	O		
12	7.5	6.5	5.5	42	M5	F04	
15	9	8.5	7.5	50	M6	F05	
15	9	10	9	50	M6	F05	
-	-	-	-	-	-	-	
22	16	16	15	70	M8	F07	
24	18	22	19	70	M8	F07	
40	30	32	30	102	M10	F10	
55	36	42	40	125	M12	F12	

VALVE SIZE		DIMENSIONS in mm									WEIGHT KG		
INCH	mm	A	A1	A2	B	C	D	E	F	RF	RTJ	BW	
3/4" x 1/2"	20 x 15	229	229	229	40	40	12.7	95	193	6.5	6.5	4	
1" x 3/4"	25 x 20	254	254	254	48	48	19	110	225	13	13	11	
1.1/4" x 1"	32 x 25	280	280	280	61	61	25.4	115	225	22	22	16	
1.1/2" x 1"	40 x 25	305	305	305	61	61	25.4	115	225	25	25	17	
2" x 1.1/2"	50 x 40	368	371	368	85	90	38	155	365	40	41	28	
3" x 2"	80 x 50	381	384	381	102	100	51	175	470	55	56	31	
4" x 3"	100 x 80	457	460	457	150	148	76	-	-	110	115	55	
6" x 4"	150 x 100	609.5	612.5	609.5	188	188	101.6	-	-	205	210	155	

DIMENSIONS in mm							ISO 5211
H	I	L	M	N	O		
12	7.5	6.5	5.5	42	M5	F04	
15	9	8.5	7.5	50	M6	F05	
15	9	10	9	50	M6	F05	
15	9	10	9	50	M6	F05	
22	16	16	15	70	M8	F07	
24	18	22	19	70	M8	F07	
40	30	32	30	102	M10	F10	
55	36	42	40	125	M12	F12	

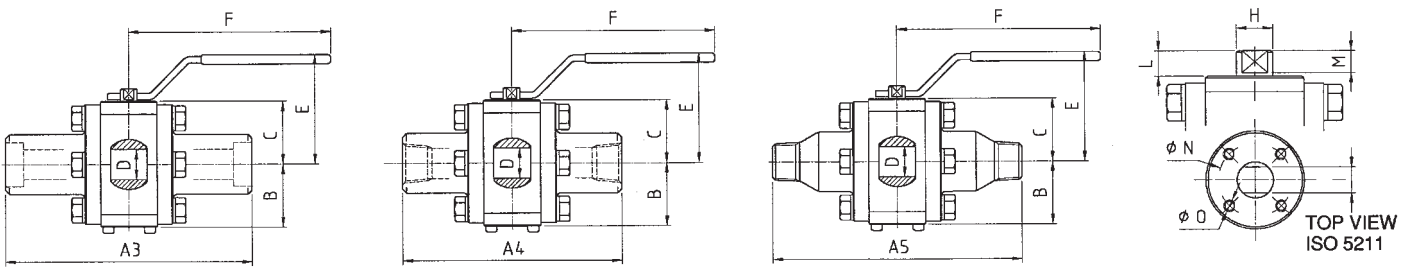

VALVE SIZE		DIMENSIONS in mm									WEIGHT KG		
INCH	mm	A3	A4	A5	B	C	D	E	F	SW	THREADED		
											FEMALE	MALE	
1/2" x 1/2"	15 x 15	216	130	216	40	40	12.7	95	193	3.5	3	3.5	
3/4" x 3/4"	20 x 20	229	145	229	48	48	19	110	225	9.5	8.5	9.5	
1" x 1"	25 x 25	254	170	254	61	61	25.4	115	225	15	14	15	
1.1/4" x 1.1/4"	32 x 32	-	-	-	-	-	-	-	-	-	-	-	
1.1/2" x 1.1/2"	40 x 40	305	220	305	85	90	38	155	365	30	27	30	
2" x 2"	50 x 50	368	240	368	102	100	51	175	470	45	40	45	
3" x 3"	80 x 80	381	-	-	150	148	76	-	-	55	-	-	
4" x 4"	100 x 100	457	-	-	188	188	101.6	-	-	100	-	-	

DIMENSIONS in mm							ISO 5211
H	I	L	M	N	O		
12	7.5	6.5	5.5	42	M5	F04	
15	9	8.5	7.5	50	M6	F05	
15	9	10	9	50	M6	F05	
-	-	-	-	-	-	-	
22	16	16	15	70	M8	F07	
24	18	22	19	70	M8	F07	
40	30	32	30	102	M10	F10	
55	36	42	40	125	M12	F12	

Threaded ends only up to 2".

VALVE SIZE		DIMENSIONS in mm									WEIGHT KG		
INCH	mm	A3	A4	A5	B	C	D	E	F	SW	THREADED		
											FEMALE	MALE	
3/4" x 1/2"	20 x 15	229	130	229	40	40	12.7	95	193	4	3.5	4	
1" x 3/4"	25 x 20	254	145	254	48	48	19	110	225	11	10	11	
1.1/4" x 1"	32 x 25	280	170	280	61	61	25.4	115	225	16	14	16	
1.1/2" x 1"	40 x 25	305	170	305	61	61	25.4	115	225	17	14	17	
2" x 1.1/2"	50 x 40	368	220	368	85	90	38	155	365	33	27	33	
3" x 2"	80 x 50	381	-	-	102	100	51	175	470	50	-	-	
4" x 3"	100 x 80	457	-	-	150	148	76	-	-	60	-	-	
6" x 4"	150 x 100	609.5	-	-	188	188	101.6	-	-	145	-	-	

DIMENSIONS in mm							ISO 5211
H	I	L	M	N	O		
12	7.5	6.5	5.5	42	M5	F04	
15	9	8.5	7.5	50	M6	F05	
15	9	10	9	50	M6	F05	
15	9	10	9	50	M6	F05	
22	16	16	15	70	M8	F07	
24	18	22	19	70	M8	F07	
40	30	32	30	102	M10	F10	
55	36	42	40	125	M12	F12	

Threaded ends only up to 2".



FCNA FCJâ 'H 85 '7 @ GG'%' \$ \$

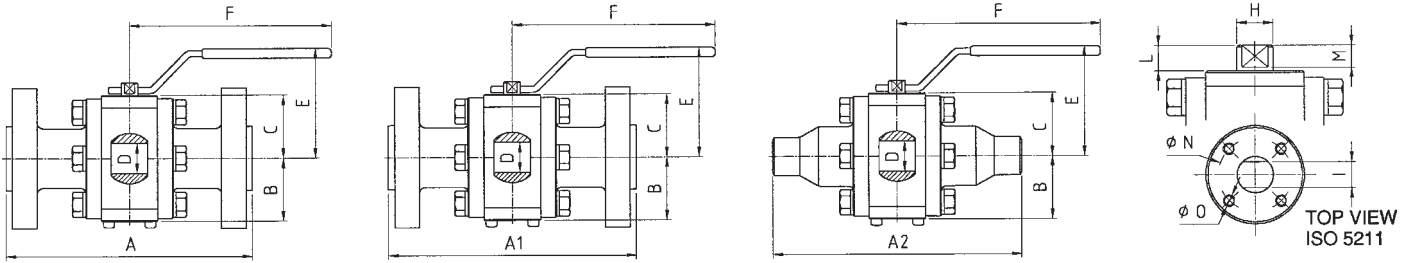

GEAR OPERATED

VALVE SIZE		DIMENSIONS in mm								WEIGHT KG		
INCH	mm	A	A1	A2	B	C	D	E	F	RF	RTJ	BW
1/2" x 1/2"	15 x 15	216	216	216	40	40	12.7	95	193	5	5	3.5
3/4" x 3/4"	20 x 20	229	229	229	48	48	19	110	225	11	11	9.5
1" x 1"	25 x 25	254	254	254	61	61	25.4	115	225	18	18	15
1.1/4" x 1.1/4"	32 x 32	-	-	-	-	-	-	-	-	-	-	-
1.1/2" x 1.1/2"	40 x 40	305	305	305	85	90	38	155	365	34	34	30
2" x 2"	50 x 50	368	371	368	102	100	51	175	470	50	50	45
3" x 3"	80 x 80	470	473	470	150	148	76	-	-	90	90	60
4" x 4"	100 x 100	546	549	546	188	188	101.6	-	-	185	190	160

DIMENSIONS in mm							ISO
H	I	L	M	N	O		5211
12	7.5	6.5	5.5	42	M5		F04
15	9	8.5	7.5	50	M6		F05
15	9	10	9	50	M6		F05
-	-	-	-	-	-		-
22	16	16	15	70	M8		F07
24	18	22	19	70	M8		F07
40	30	32	30	102	M10		F10
55	36	42	40	125	M12		F12

VALVE SIZE		DIMENSIONS in mm								WEIGHT KG		
INCH	mm	A	A1	A2	B	C	D	E	F	RF	RTJ	BW
3/4" x 1/2"	20 x 15	229	229	229	40	40	12.7	95	193	6.5	6.5	4
1" x 3/4"	25 x 20	254	254	254	48	48	19	110	225	13	13	11
1.1/4" x 1"	32 x 25	280	280	280	61	61	25.4	115	225	22	22	16
1.1/2" x 1"	40 x 25	305	305	305	61	61	25.4	115	225	25	25	17
2" x 1.1/2"	50 x 40	368	371	368	85	90	38	155	365	40	40	33
3" x 2"	80 x 50	470	473	470	102	100	51	175	470	68	69	48
4" x 3"	100 x 80	546	549	546	150	148	76	-	-	120	122	75
6" x 4"	150 x 100	705	711	705	188	188	101.6	-	-	230	235	155

DIMENSIONS in mm							ISO
H	I	L	M	N	O		5211
12	7.5	6.5	5.5	42	M5		F04
15	9	8.5	7.5	50	M6		F05
15	9	10	9	50	M6		F05
15	9	10	9	50	M6		F05
22	16	16	15	70	M8		F07
24	18	22	19	70	M8		F07
40	30	32	30	102	M10		F10
55	36	42	40	125	M12		F12

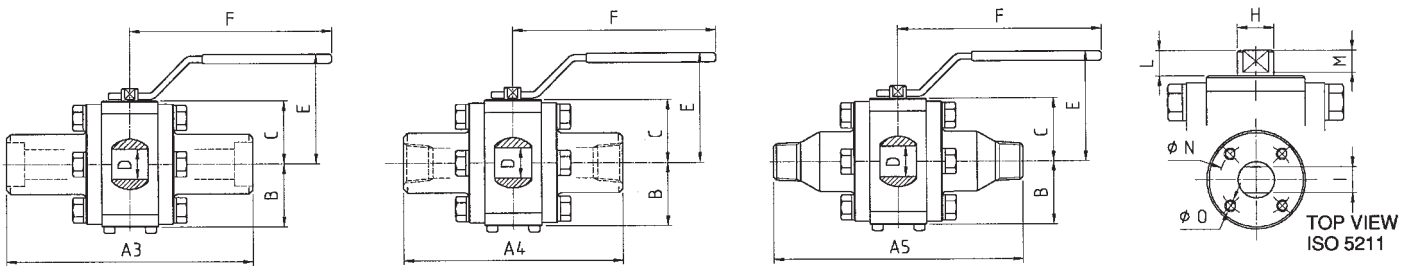

VALVE SIZE		DIMENSIONS in mm								WEIGHT KG		
INCH	mm	A3	A4	A5	B	C	D	E	F	SW	THREADED FEMALE	THREADED MALE
1/2" x 1/2"	15 x 15	216	130	216	40	40	12.7	95	193	3.5	3	3.5
3/4" x 3/4"	20 x 20	229	145	229	48	48	19	110	225	9	8.5	9.5
1" x 1"	25 x 25	254	170	254	61	61	25.4	115	225	15	14	15
1.1/4" x 1.1/4"	32 x 32	-	-	-	-	-	-	-	-	-	-	-
1.1/2" x 1.1/2"	40 x 40	305	220	305	85	90	38	155	365	30	27	30
2" x 2"	50 x 50	368	240	368	102	100	51	175	470	45	40	45
3" x 3"	80 x 80	470	-	-	150	148	76	-	-	60	-	-
4" x 4"	100 x 100	546	-	-	188	188	101.6	-	-	130	-	-

DIMENSIONS in mm							ISO
H	I	L	M	N	O		5211
12	7.5	6.5	5.5	42	M5		F04
15	9	8.5	7.5	50	M6		F05
15	9	10	9	50	M6		F05
-	-	-	-	-	-		-
22	16	16	15	70	M8		F07
24	18	22	19	70	M8		F07
40	30	32	30	102	M10		F10
55	36	42	40	125	M12		F12

Threaded ends only up to 2".

VALVE SIZE		DIMENSIONS in mm								WEIGHT KG		
INCH	mm	A3	A4	A5	B	C	D	E	F	SW	THREADED FEMALE	THREADED MALE
3/4" x 1/2"	20 x 15	229	130	229	40	40	12.7	95	193	4	3.5	4
1" x 3/4"	25 x 20	254	145	254	48	48	19	110	225	11	10	11
1.1/4" x 1"	32 x 25	280	170	280	61	61	25.4	115	225	16	14	16
1.1/2" x 1"	40 x 25	305	170	305	61	61	25.4	115	225	17	14	17
2" x 1.1/2"	50 x 40	368	220	368	85	90	38	155	365	33	27	33
3" x 2"	80 x 50	470	-	-	102	100	51	175	470	48	-	-
4" x 3"	100 x 80	546	-	-	150	148	76	-	-	85	-	-
6" x 4"	150 x 100	705	-	-	188	188	101.6	-	-	155	-	-

DIMENSIONS in mm							ISO
H	I	L	M	N	O		5211
12	7.5	6.5	5.5	42	M5		F04
15	9	8.5	7.5	50	M6		F05
15	9	10	9	50	M6		F05
15	9	10	9	50	M6		F05
22	16	16	15	70	M8		F07
24	18	22	19	70	M8		F07
40	30	32	30	102	M10		F10
55	36	42	40	125	M12		F12

Threaded ends only up to 2".



FCNA FCJâ 'H 85 '7 @ GG&) \$\$

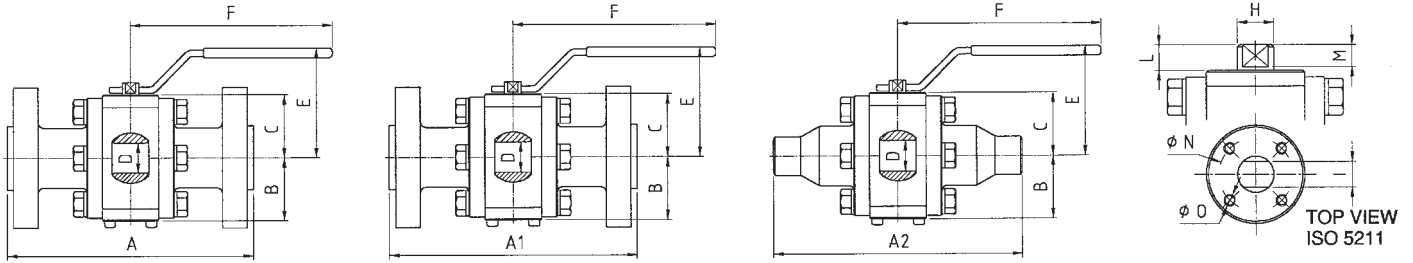

GEAR OPERATED

VALVE SIZE		FULL BORE DIMENSIONS in mm								WEIGHT KG		
INCH	mm	A	A1	A2	B	C	D	E	F	RF	RTJ	BW
1/2" x 1/2"	15 x 15	263	263	263	49	49	12.7	110	225	10	10	8
3/4" x 3/4"	20 x 20	273	273	273	49	49	16	110	225	20	20	15
1" x 1"	25 x 25	308	308	308	62	62	21	115	225	26	26	20
1.1/4" x 1.1/4"	32 x 32	-	-	-	-	-	-	-	-	-	-	-
1.1/2" x 1.1/2"	40 x 40	384	387	384	92	85	34	155	365	42	44	38
2" x 2"	50 x 50	451	454	451	108	100	44.5	170	470	72	75	42
3" x 3"	80 x 80	578	584	578	154	142	64	-	-	160	163	120

MANUAL GEAR OPERATION OR AUTOMATION DIMENSIONS in mm							ISO 5211
H	I	L	M	N	O		
15	9	8.5	7.5	50	M6	F05	
15	9	8.5	7.5	50	M6	F05	
15	9	10	9	50	M6	F05	
-	-	-	-	-	-	-	-
22	16	16	15	70	M8	F07	
24	18	22	19	70	M8	F07	
40	30	31	28	102	M10	F10	

VALVE SIZE		REDUCED BORE DIMENSIONS in mm								WEIGHT KG		
INCH	mm	A	A1	A2	B	C	D	E	F	RF	RTJ	BW
3/4" x 1/2"	20 x 15	273	273	273	49	49	12.7	110	225	12	12	8.5
1" x 3/4"	25 x 20	308	308	308	49	49	16	110	225	25	25	20
1.1/4" x 1"	32 x 25	349	352	349	62	62	21	115	225	32	33	25
1.1/2" x 1"	40 x 25	384	387	384	62	62	21	115	225	35	37	28
2" x 1.1/2"	50 x 40	451	454	451	92	85	34	155	365	52	55	40
3" x 2"	80 x 50	578	584	578	108	100	44.5	170	470	100	103	45
4" x 3"	100 x 80	673	682.5	673	154	142	64	-	-	215	220	135

MANUAL GEAR OPERATION OR AUTOMATION DIMENSIONS in mm							ISO 5211
H	I	L	M	N	O		
15	9	8.5	7.5	50	M6	F05	
15	9	8.5	7.5	50	M6	F05	
15	9	8.5	9	50	M6	F05	
15	9	10	9	50	M6	F05	
22	16	16	15	70	M8	F07	
24	18	22	19	70	M8	F07	
40	30	31	28	102	M10	F10	

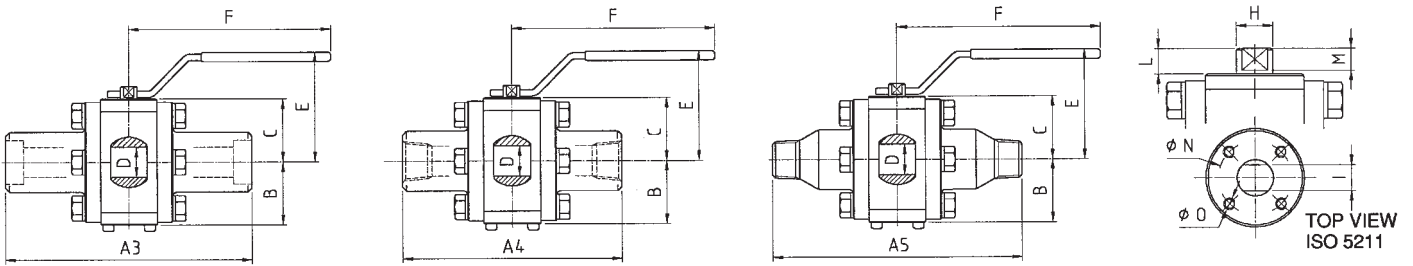

VALVE SIZE		FULL BORE DIMENSIONS in mm								WEIGHT KG		
INCH	mm	A3	A4	A5	B	C	D	E	F	SW	THREADED	
											FEMALE	MALE
1/2" x 1/2"	15 x 15	263	150	263	49	49	12.7	110	225	8	7	8
3/4" x 3/4"	20 x 20	273	150	273	49	49	16	110	225	15	12	15
1" x 1"	25 x 25	308	170	308	62	62	21	115	225	20	18	20
1.1/4" x 1.1/4"	32 x 32	-	-	-	-	-	-	-	-	-	-	-
1.1/2" x 1.1/2"	40 x 40	384	220	384	92	85	34	155	365	40	36	40
2" x 2"	50 x 50	451	260	451	108	100	44.5	170	470	45	40	45
3" x 3"	80 x 80	578	-	-	154	142	64	-	-	120	-	-

MANUAL GEAR OPERATION OR AUTOMATION DIMENSIONS in mm							ISO 5211
H	I	L	M	N	O		
15	9	8.5	7.5	50	M6	F05	
15	9	8.5	7.5	50	M6	F05	
15	9	10	9	50	M6	F05	
-	-	-	-	-	-	-	-
22	16	16	15	70	M8	F07	
24	18	22	19	70	M8	F07	
40	30	31	28	102	M10	F10	

Threaded ends only up to 2".

VALVE SIZE		REDUCED BORE DIMENSIONS in mm								WEIGHT KG		
INCH	mm	A3	A4	A5	B	C	D	E	F	SW	THREADED	
											FEMALE	MALE
3/4" x 1/2"	20 x 15	273	150	273	49	49	12.7	110	225	8.5	7	8.5
1" x 3/4"	25 x 20	308	150	308	49	49	16	110	225	20	12	20
1.1/4" x 1"	32 x 25	349	170	349	62	62	21	115	225	25	18	25
1.1/2" x 1"	40 x 25	384	170	384	62	62	21	115	225	28	18	28
2" x 1.1/2"	50 x 40	451	220	451	92	85	34	155	365	42	38	42
3" x 2"	80 x 50	578	-	-	108	100	44.5	170	470	45	-	-
4" x 3"	100 x 80	673	-	-	154	142	64	-	-	135	-	-

MANUAL GEAR OPERATION OR AUTOMATION DIMENSIONS in mm							ISO 5211
H	I	L	M	N	O		
15	9	8.5	7.5	50	M6	F05	
15	9	8.5	7.5	50	M6	F05	
15	9	10	9	50	M6	F05	
15	9	10	9	50	M6	F05	
22	16	16	15	70	M8	F07	
24	18	22	15	70	M8	F07	
40	30	31	28	102	M10	F10	

Threaded ends only up to 2".



79FH ⇒ HM

Lloyd's Register

Via F.lli Baracca, 30 - 24060 S. Paolo d'Argon (BG)
 Telefono 030 2446112
 Fax 030 2446234

Obj. No: EAC 2004/1 - 24
 Your Ref: EAC 2004/1/24
 Date: January 2004, 1994

STARLINE S.P.A.
 Via Francesco Baracca 30
 24060 SAN PAOLO D'ARGON
 (BERGAMO) - ITALY

This is to certify that the following No. 24 Starline Transion Mounted Ball valves, selected at random tests from manufacturer's current production have satisfactorily passed FINE TEST according to BS 6755 PART 2:1995 (API 600, 6th Edition), May 1992, and API 600 First Edition, May 1, 1985 (retitled May 1, 1985).

STARLINE BALL VALVE TYPE: ULTRAFLEX 2.0 - TRANSION MOUNTED

ITEM No.	SIZE	DATE	CLASS	TYPE	TEST	RESULT
1	100/150	28/11/03	100	100	100	100
2	100/150	28/11/03	100	100	100	100
3	100/150	28/11/03	100	100	100	100
4	100/150	28/11/03	100	100	100	100
5	100/150	28/11/03	100	100	100	100
6	100/150	28/11/03	100	100	100	100
7	100/150	28/11/03	100	100	100	100
8	100/150	28/11/03	100	100	100	100
9	100/150	28/11/03	100	100	100	100
10	100/150	28/11/03	100	100	100	100
11	100/150	28/11/03	100	100	100	100
12	100/150	28/11/03	100	100	100	100
13	100/150	28/11/03	100	100	100	100
14	100/150	28/11/03	100	100	100	100
15	100/150	28/11/03	100	100	100	100
16	100/150	28/11/03	100	100	100	100
17	100/150	28/11/03	100	100	100	100
18	100/150	28/11/03	100	100	100	100
19	100/150	28/11/03	100	100	100	100
20	100/150	28/11/03	100	100	100	100
21	100/150	28/11/03	100	100	100	100
22	100/150	28/11/03	100	100	100	100
23	100/150	28/11/03	100	100	100	100
24	100/150	28/11/03	100	100	100	100

Approved by Lloyd's Register

Note 1 - Valve tested in accordance with BS 6755 PART 2:1995 (API 600, 6th Edition), May 1992, and API 600 First Edition, May 1, 1985 (retitled May 1, 1985).

Note 2 - Valve tested in accordance with BS 6755 PART 2:1995 (API 600, 6th Edition), May 1992, and API 600 First Edition, May 1, 1985 (retitled May 1, 1985).

Lloyd's Register of Shipping, registered office: 17 Broad Street, London EC4A 3DF

ORIGINAL LICENSE NO. 6D-0233

American Petroleum Institute

Certificate of Authority to Use Official Monogram

The AMERICAN PETROLEUM INSTITUTE hereby grants to

STARLINE S. P. A.
 S. Paolo D'Argon, Bergamo, Italy

the right to use the Official Monogram  on manufactured products under the conditions specified in the official publications of the American Petroleum Institute entitled API Spec Q1 and Specification 6D

and in accordance with the provisions of the License Agreement.

In all cases where the Official Monogram  is applied, the Monogram should be used in conjunction with this certificate number **6D-0233**

The American Petroleum Institute reserves the right to revoke this authorization to use the Official Monogram, for any reason satisfactory to the Board of Directors of the American Petroleum Institute.

Effective Date: JULY 24, 2001
 Expiration Date: JULY 24, 2004

AMERICAN PETROLEUM INSTITUTE,
 Secretary

A. William Smith



TÜV

CERTIFICATE

EXAMINATION AS MANUFACTURER ACCORDING TO AD-MERKBLATT HP 0 / TRB 801 No. 45

Starline S.p.A., Via F.lli Baracca, 30 I - 24060 S. Paolo d'Argon (BG)

This is to certify that the named company has been audited and approved according to AD-Merkblatt HP 0 and TRB 801 No. 45. The scope of the audit and all other relevant data are detailed in our report No. AW6/0494.

All pertinent requirements have been met.

Among other things, the above-mentioned company

- has facilities permitting manufacturing and inspection in compliance with the current technical standards,
- operates a quality system which guarantees that manufacturing and inspection of the products stated in our report are in conformity with the technical rules and standards
- employs qualified supervisory and inspection personnel.

The certificate expires on April 2003

Milan, 18.10.2000

TÜV BAYERN HESSEN SACHSEN SÜDWEST E.V.

Business Unit Industrial Plants
 Department Material and Welding Technology

[Signature]



CERTIFICATE OF APPROVAL

This is to certify that the Quality Management System of

Star Line S.p.A.
San Paolo D'Argon (Bergamo)
Italy

has been approved by Lloyd's Register Quality Assurance to the following Quality Management System Standards:

ISO 9001:1994
EN ISO 9001:1994
BS EN ISO 9001:1994
UNI EN ISO 9001:1994

The Quality Management System is applicable to:

Design and assembly of carbon, alloy and stainless steel floating ball and transion mounted ball valves from ND 1/4" to ND 8", operated manually or by selected actuator.

Approval Certificate No: LRC 200047
 Original Approval: 18th June 1992
 Current Certificate: 22nd June 2001
 Certificate Expires: 14th December 2003

[Signature]
 Issued by: LRCQA Milan



LLOYD'S REGISTER QUALITY ASSURANCE



CHEMICAL AND MECHANICAL REQUIREMENTS

SPECIFICATION ACCORDING TO ASTM VOLUME 01.01 AND 01.05			CARBON STEEL	LOW TEMPERATURE STEEL AS PER ASTM		MARTENSITIC STEEL	AUSTENITIC STAINLESS STEEL AS PER ASTM A182				ASTM A182	17-4-PH
			A 105	A350-LF2	A350-LF3	A276-420	F316	F316L	F321	F44	F51	A564-630
CHEMICAL REQUIREMENTS	CARBON	C % max	*0.22	*0.22	0.20	OVER 0.15	0.08	0.035	0.08	0.020	0.030	0.07
	MANGANESE	Mn % max	0.60-1.05	0.60-1.35	0.90	1.00	2.00	2.00	2.00	1.00	2.00	1.00
	PHOSPHORUS	P % max	0.040	0.035	0.035	0.040	0.040	0.040	0.040	0.030	0.030	0.040
	SULFUR	S % max	0.050	0.040	0.040	0.030	0.030	0.030	0.030	0.010	0.020	0.030
	SILICON	Si % max	0.35	0.15-0.30	0.20-0.35	1.00	1.00	1.00	1.00	0.80	1.00	1.00
	NICKEL	Ni % max	0.40	0.40	3.3-3.7	-	10.0-14.0	10.0-15.0	9.0-12.0	17.5-18.5	4.5-6.5	3.00-5.00
	CHROMIUM	Cr % max	0.30	0.30	0.30	12.00-14.00	16.0-18.0	16.0-18.0	17min.	19.5-20.5	21.0-23.0	15.0-17.5
	MOLYBDENUM	Mo % max	0.12	0.12	0.12	-	2.00-3.00	2.00-3.00	-	6.0-6.5	2.5-3.5	-
	VANADIUM	V % max	0.03	0.03	0.03	-	-	-	-	-	-	-
	NIOBIO/COLUMBIUM	Nb % max	0.02	0.02	0.02	-	-	-	-	-	-	-
	COPPER	Cu % max	0.40	0.40	0.40	-	-	-	-	0.50-1.00	-	3.00-5.00
TITANIUM	Ti % max	-	-	-	-	-	-	0.70	-	-	-	

MECHANICAL REQUIREMENTS AT ROOM TEMPERATURE			70	70-95	70-95		75	70	75	94	90	190
	TENSILE STRENGTH	K.s.i. min	70	70-95	70-95			75	70	75	94	90
	MPa min	485	485-655	485-655			515	485	515	650	620	1310
YELD STRENGTH	K.s.i. min	36	36	37.5			30	25	30	44	65	170
	MPa min	250	250	260			205	170	205	300	450	1170
ELONGATION IN 2	% min	22	22	22			30	30	30	35	25	10
REDUCION OF AREA	% min	30	30	30			50	50	50	50	45	40
BRINELL HARDNESS		137-187										388
CORRESPONDANCE TO EN 10088 PART. 3						1.4021	1.4401	1.4404	1.4541	1.4547	1.4462	1.4542

* STARLINE CARBON CONTENT LIMITED TO 0.22%. STANDARD IMPACT TEST CHARPY-V AT-45.6° C (-50°F) FOR LF2 AND -101.1° C (-150° F) FOR LF3. FOR PRODUCT ANALYSIS TOLERANCES SEE ABOVE MENTIONED ASTM VOLUMES. FOR BOLTING MATERIALS SEE ASTM A 193 AND ASTM A 320.

STEEL STANDARDS COMPARISON*

ASTM	UNS/AISI	DIN	AFNOR	BS	JIS
A105	AISI 1020	G22 1.0402	A 48 -XC18S	1503-221-490 (En 3A)	SF50 (SC30)-(S28C)
A182 - F1	K 12822	15.Mo 3 1.5415	-	1503-240-420	SFHV 12 B -G 3213
- F5	K 41545	12 CrMo 19.5 1.7362	Z 12 CD 5	1503-625-520	SFHV 25 -G 3213
- F11	K 11572	24 CrMoV-55 1.7733	15 CD 5.05	1506-661-440	SFHV 23 B -G 3213
- F22	K 21590	10 CrMo 9.10 1.7380	12 CD 9.10	1503-622-490	SFHV 24 B -G 3213
- F304	S 30400	X5CrNi 18.9 1.4301	Z6 CN 18.09	1503-304-S15	SUS 304 -G 4303
- F304H	S 30409	X5 CrNi 18.9 1.4301	Z6 CN 18.09	1503-304-S49	SUS 304 H -G 4303
- F304L	S 30403	X2 CrNi 18.9 1.4306	Z2 CN 18.10	1503-304-S12	SUS 304 L -G 4303
- F316	S 31600	X5 CrNiMo 18.10 1.4401	Z6 CND 17.11	1503-316-S16	SUS 316 -G 4303
- F316H	S 31609	X5 CrNiMo 18.12	-	1503-316-S49	SUS 316 H -G 4303
- F316L	S 31603	X2 CrNiMo 18.10 1.4404	Z6 CND 17.12	1503-316-S12	SUS 316 L -G 4303
- F321	S 32100	X10 CrNiTi 18.9 1.4541	Z6- CNT 18.10	1503-321-S31	SUS 321
- F347	S 34700	X10 CrNiNb 18.9 1.4550	Z6 CN Nb 18.10	1503-347-S17	SUS 347
A193 - B6 (A276- Type 410)	AISI 410 S 41000	X10 Cr 13 1.4006	Z10 C 13	410-S21	SUS 410 -G 4303
- B7	AISI 4140	42 CrMo 4 1.7225	42 CD 4	1506-621-A	SNB 7 - G 4107 (SMC 4)
- B8	AISI 304	X5 CrNi 18.9 1.4301	Z6 CN 18.09	1506-801-B	SUS 304 G 4303
- B8M	AISI 316	X5 CrNiMo 18.10 1.4401	Z6 CND 17.11	1506-845	SUS 316 G 4303
- B16	-	24 CrMoV 55 1.7733	36 CDV 4.05	1506-661	SNB 16 G 4107
A194 - 2H	-	C45 1.0503	A60/CC45	1506-162	S45C - G 4051
Gr. 4	-	24 CrMo 5 1.7258	40 D2	1506-240	-
Gr. 8	AISI 304	X5 CrNi 18.9 1.4301	Z6 CN 18.09	1506-801-B	SUB 304 - G 4303
Gr. 8M	AISI 316	X5 CrNiMo 18.10 1.4401	Z6 CND 17.11	1506-845	SUB 316 - G 4303
A276 - Type 420	AISI 420 S 42000	X30 Cr 13 1.4028	Z30 C13	420-S45	SUS 420 J2
A320 - L7	AISI 4140	42 Cr Mo 4 1.7225	42 CD 4	1506-621-A	SCM3 - G 4105
A350 - LF2	-	TT St E 36 1.0508	A48 FP1 (A 36-208)	1503-223-410 (32A LT50)	-
A582 -Type 303	AISI 303 S 30300	X10 CrNiS 18.9 1.4305	Z10 CNF 18.09	303-S21	SUS 303
- Type 416	AISI 416 S41600	X12 CrS 13 1.4005	Z12 CF 13	416-S21	SUS 416

* Above comparison is to be intended as a guide.

A light difference requirements may be found between one Standard and another (i.e.: chemical composition, supplementary mechanical tests, special heat treatment, etc.). Therefore, the use of an equivalent standard is always subject to Customer's agreement.



D 9JC8 B&H5 6I @ 5

Inches - millimeters 1" = 25,400 m/m

Inches	0	1/16	1/8	3/16	1/4	5/16	3/8	7/16	1/2	9/16	5/8	11/16	3/4	13/16	7/8	15/16	Inches
0	0,000	1,587	3,175	4,762	6,350	7,937	9,525	11,112	12,700	14,287	15,875	17,462	19,050	20,631	22,225	23,912	0
1	25,400	26,987	28,574	30,162	31,749	33,337	34,924	36,512	38,099	39,687	41,274	42,862	44,449	46,037	47,624	49,212	1
2	50,799	52,387	53,974	55,561	57,149	58,736	60,324	61,911	63,499	65,086	66,674	68,261	69,849	71,436	73,024	74,611	2
3	79,199	77,786	79,374	80,961	82,549	84,137	85,723	87,311	88,898	90,486	92,073	93,661	95,248	96,836	98,423	100,01	3
4	101,60	103,19	104,77	106,36	107,95	109,54	111,12	112,71	114,30	115,89	117,47	119,06	120,65	122,24	123,82	125,41	4
5	127,00	128,59	130,17	131,76	133,35	134,94	136,52	138,11	139,70	141,28	142,87	144,46	146,05	147,63	149,22	150,81	5
6	152,40	153,98	155,57	157,16	158,75	160,33	161,92	163,51	165,10	166,68	168,27	169,86	171,45	173,03	174,62	176,21	6
7	177,80	179,38	180,97	182,56	184,15	185,73	187,32	188,91	190,50	192,08	193,67	195,26	196,85	198,43	200,02	201,61	7
8	203,20	204,78	206,37	207,96	209,13	211,13	212,72	214,31	215,90	217,48	219,07	220,66	222,25	223,83	225,42	227,01	8
9	228,60	230,18	231,77	233,36	234,95	236,53	238,12	239,71	241,30	242,88	244,47	246,06	247,65	249,23	250,82	252,41	9
10	254,00	255,58	257,17	258,76	260,35	261,93	263,52	265,11	266,70	268,28	269,87	271,46	273,05	274,63	276,22	277,81	10
11	279,39	280,98	282,57	284,16	285,74	287,33	288,92	290,51	292,09	293,68	295,27	296,86	298,44	300,03	301,62	303,21	11
12	304,79	306,38	307,97	309,56	311,14	312,73	314,32	315,91	317,49	319,08	320,67	322,26	323,84	325,43	327,02	328,61	12
13	330,19	331,78	333,37	334,96	336,54	338,13	339,72	341,31	342,89	344,48	346,07	347,66	349,24	350,83	352,42	354,01	13
14	355,59	357,18	358,77	360,36	361,94	363,53	365,12	366,71	368,29	369,88	371,47	373,06	374,64	376,23	377,82	379,41	14
15	380,99	382,17	384,17	385,76	387,34	388,93	390,52	392,11	393,69	395,28	396,87	398,46	400,04	401,63	403,22	404,81	15
16	406,39	407,98	409,57	411,16	412,74	414,33	415,92	417,50	419,09	420,68	422,27	423,85	425,44	427,03	428,62	430,20	16
17	431,79	433,38	434,97	436,55	438,14	439,73	441,32	442,90	444,49	446,08	447,67	449,25	450,84	452,43	454,02	455,60	17
18	457,19	458,78	460,37	461,95	463,54	465,13	466,72	468,30	469,89	471,48	473,07	474,65	476,24	477,83	479,42	481,00	18
19	482,59	484,18	485,77	487,35	488,94	490,53	492,12	493,70	495,29	496,88	498,47	500,05	501,64	503,23	504,82	506,40	19

general Formula °F = (°C x 9/5) + 32
°C = (°F - 32) x 5/9

Degrees Fahrenheit - Centigrade

°C	°F	°C	°F	°C	°F	°C	°F	°C	°F	°C	°F	°C	°F	
-169	-273	-459,4	4,4	40	104	179	355	671	354	670	1238	529	985	1805
-168	-270	-454	7,2	45	113	182	360	680	357	675	1247	532	990	1814
-165	-265	-445	10,0	50	122	185	365	689	360	680	1256	535	995	1823
-162	-260	-436	12,8	55	131	188	370	698	363	685	1265	538	1000	1832
-159	-255	-427	15,6	60	140	191	375	707	366	690	1274	541	1005	1841
-157	-250	-418	18,3	65	149	193	380	716	368	695	1283	543	1010	1850
-154	-245	-409	21,1	70	158	196	385	725	371	700	1292	546	1015	1859
-151	-240	-400	23,9	75	167	199	390	734	374	705	1301	549	1020	1868
-148	-235	-391	26,7	80	176	202	395	743	377	710	1310	552	1025	1877
-146	-230	-382	29,4	85	185	204	400	752	379	715	1319	554	1030	1886
-143	-225	-373	32,2	90	194	207	405	761	382	720	1328	557	1035	1895
-140	-220	-364	35,0	95	203	210	410	770	385	725	1337	560	1040	1904
-137	-215	-355	37,8	100	212	213	415	779	388	730	1346	563	1045	1913
-134	-210	-346	40,6	105	221	216	420	788	391	735	1355	566	1050	1922
-132	-205	-337	43,3	110	230	218	425	797	393	740	1364	568	1055	1931
-129	-200	-328	46,1	115	239	221	430	806	396	745	1373	571	1060	1940
-126	-195	-319	48,9	120	248	224	435	815	399	750	1382	574	1065	1949
-123	-190	-310	51,7	125	257	227	440	824	402	755	1391	577	1070	1958
-121	-185	-301	54,4	130	266	229	445	833	404	760	1400	579	1075	1967
-118	-180	-292	57,2	135	275	232	450	842	407	765	1409	582	1080	1976
-115	-175	-283	60,0	140	284	235	455	851	410	770	1418	585	1085	1985
-112	-170	-274	62,8	145	293	238	460	860	413	775	1427	588	1090	1994
-109	-165	-265	65,6	150	302	241	465	869	416	780	1436	590	1095	2003
-107	-160	-256	68,3	155	311	243	470	878	418	785	1445	593	1100	2012
-104	-155	-247	71,1	160	320	246	475	887	421	790	1454	596	1105	2021
-101	-150	-238	73,9	165	329	249	480	896	424	795	1463	599	1110	2030
-98,3	-145	-229	76,7	170	338	252	485	905	427	800	1472	602	1115	2039
-95,6	-140	-220	79,4	175	347	254	490	914	429	805	1481	604	1120	2048
-92,8	-135	-211	82,2	180	356	257	495	923	432	810	1490	607	1125	2057
-90,0	-130	-202	85,0	185	365	260	500	932	435	815	1499	610	1130	2066
-87,2	-125	-193	87,8	190	374	263	505	941	438	820	1508	613	1135	2075
-84,4	-120	-184	90,6	195	383	266	510	950	441	825	1517	616	1140	2084
-81,6	-115	-175	93,3	200	392	268	515	959	443	830	1526	618	1145	2093
-78,9	-110	-166	96,1	205	401	271	520	968	446	835	1535	621	1150	2102
-76,1	-105	-157	98,9	210	410	274	525	977	449	840	1544	624	1155	2111
-73,3	-100	-148	102	215	419	277	530	986	452	845	1553	627	1160	2120
-70,6	-95	-139	104	220	428	279	535	995	454	850	1562	629	1165	2129
-67,8	-90	-130	107	225	437	282	540	1004	457	855	1571	632	1170	2138
-65,0	-85	-121	110	230	446	285	545	1013	460	860	1580	635	1175	2147
-62,2	-80	-112	113	235	455	288	550	1022	463	865	1589	638	1180	2156
-59,4	-75	-103	115	240	464	291	555	1031	466	870	1598	641	1185	2165
-56,7	-70	-94	118	245	473	293	560	1040	468	875	1607	643	1190	2174
-53,9	-65	-85	121	250	482	296	565	1049	471	880	1616	646	1195	2183
-51,1	-60	-76	124	255	491	299	570	1058	474	885	1625	649	1200	2192
-48,3	-55	-67	127	260	500	302	575	1067	477	890	1634	652	1205	2201
-45,6	-50	-58	129	265	509	304	580	1076	479	895	1643	654	1210	2210
-42,8	-45	-49	132	270	518	307	585	1085	482	900	1652	657	1215	2219
-40,0	-40	-40	135	275	527	310	590	1094	485	905	1661	660	1220	2228
-37,2	-35	-31	138	280	536	313	595	1103	488	910	1670	663	1225	2237
-34,4	-30	-22	141	285	545	316	600	1112	491	915	1679	666	1230	2246
-31,7	-25	-13	143	290	554	318	605	1121	493	920	1688	668	1235	2255
-28,9	-20	-4	146	295	563	321	610	1130	496	925	1697	671	1240	2264
-26,1	-15	5	149	300	572	324	615	1139	499	930	1706	674	1245	2273
-23,3	-10	14	152	305	581	327	620	1148	502	935	1715	677	1250	2282
-20,6	-5	23	154	310	590	329	625	1157	504	940	1724	679	1255	2291
-17,8	0	32	157	315	599	332	630	1166	507	945	1733	682	1260	2300
-15,0	5	41	160	320	608	335	635	1175	510	950	1742	685	1265	2309
-12,2	10	50	163	325	617	338	640	1184	513	955	1751	688	1270	2318
-9,4	15	59	166	330	626	341	645	1193	516	960	1760	691	1275	2327
-6,7	20	68	168	335	635	343	650	1202	518	965	1769	693	1280	2336
-3,9	25	77	171	340	644	346	655	1211	521	970	1778	696	1285	2345
-1,1														

