

# **GEMÜ C53 iComLine**

## **Motorized control valve**



### **Features**

- Control valve for ultra pure applications in the semiconductor industry
- High-resolution linear actuator with stepper motor
- Diaphragm globe valve based on the iComLine series
- Tried and tested plug diaphragm design
- All media wetted parts are made of PFA or PTFE
- 1 million qualified control switching cycles
- Cleanroom manufacturing (HP version), complies with SEMI F 57

### **Description**

The 2/2-way diaphragm globe valve GEMÜ C53 iComLine was developed for precise and demanding control applications in semiconductor production. The sealing concept of the valve is based on the tried and tested GEMÜ PD design, whereby actuator and medium are separated by a PTFE regulating cone. As the regulating cone contour, actuator stroke and connection size can be customized to meet customers' requirements, the GEMÜ C53 iComLine satisfies virtually all control and flow requirements of the high-tech semiconductor industry. Thanks to the combination of the precise stepper motor with ultra pure body materials, it is particularly suitable for lithography, CMP, and etching processes, as well as applications in the analysis field of any semiconductor production.

### **Technical specifications**

- **Media temperature:** 10 to 150 °C
- **Ambient temperature:** 0 to 40 °C
- **Operating pressure:** 0 to 6 bar
- **Connection sizes:** 1/4" to 3/4"
- **Body configurations:** 2/2-way body
- **Connection types:** Flare | PrimeLock® | Super 300 Type Pillar®
- **Body materials:** PFA | PTFE TFM™
- **Seal material:** PTFE TFM™
- **Supply voltage:** 24 V DC
- **Input signals:** 0 - 10 V | 4 - 20 mA
- **Actuating speed:** Max. 2 mm/s
- **Protection class:** IP65

Technical data depends on the respective configuration

further information  
webcode: GW-C53



## Product description

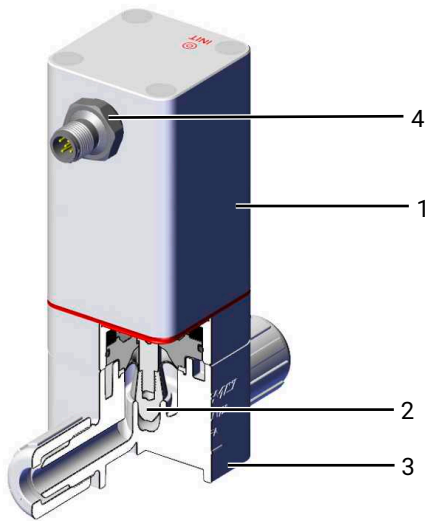

No.	Name	Materials
1	Actuator	External actuator parts made of PVDF
2	Control PD	PTFE TFM™
3	Valve body	PFA, PTFE
4	Electrical connection	PPS

## Availability

Connection size	Connection type		
	Flare (code 73, 75 77), Prime-Lock (code PL)	Flare (code 73, 75 77), Prime-Lock (code PL)	Super 300 Pillar (code 79)
	Valve body material		
	PFA (code 30)	PTFE (code 26)	PTFE (code 26)
1/4"	-	X	X
3/8"	-	X	X
1/2"	X	-	X
3/4"	X	-	X

## Order data

The order data provide an overview of standard configurations.

Please check the availability before ordering. Other configurations available on request.

## Order codes

1 Type	Code
Plastic globe valve, electrical	C53

2 Connection size	Code
1/4", international code: 4	4
3/8", international code: 6	6
1/2", international code: 8	8
3/4", international code: 12	12

3 Body configuration	Code
2/2-way body	D

4 Connection type	Code
Flare connection with CPFA union nut	73
Flare connection with PVDF union nut	75
Flare connection with PFA union nut	77
Super 300 type Pillar connection	79
PrimeLock connection	PL

5 Valve body material	Code
PFA, perfluoroalkoxy	30
Modified PTFE, polytetrafluoroethylene	26

6 Seal material	Code
PTFE	5

7 Voltage/Frequency	Code
24 V DC	C1

8 Control module	Code
Positioner 4–20 mA Close error position	S1
Positioner 0–10 V Close error position	V1

9 Actuator version	Code
Actuator size 2 Seat diameter 9.55 mm	2A

10 Regulating cone	Code
1 m <sup>3</sup> /h – mod.EQ	R3234
1 m <sup>3</sup> /h – linear	R3235

11 High Purity version	Code
High Purity	HP

## Order example

Ordering option	Code	Description
1 Type	C53	Plastic globe valve, electrical
2 Connection size	12	3/4", international code: 12
3 Body configuration	D	2/2-way body
4 Connection type	75	Flare connection with PVDF union nut
5 Valve body material	30	PFA, perfluoroalkoxy
6 Seal material	5	PTFE
7 Voltage/Frequency	C1	24 V DC
8 Control module	S1	Positioner 4–20 mA Close error position
9 Actuator version	2A	Actuator size 2 Seat diameter 9.55 mm
10 Regulating cone	R3235	1 m <sup>3</sup> /h – linear
11 High Purity version	HP	High Purity

## Technical data

### Medium

**Working medium:** Corrosive, inert, gaseous and liquid media which have no negative impact on the physical and chemical properties of the body and diaphragm material.

### Temperature

**Media temperature:** 10 – 150 °C  
Observe pressure/temperature diagram

**Ambient temperature:** 0 – 40 °C

**Storage temperature:** -10 – 40 °C

### Pressure

**Operating pressure:** 0 – 6 bar

**Pressure/temperature diagram:**

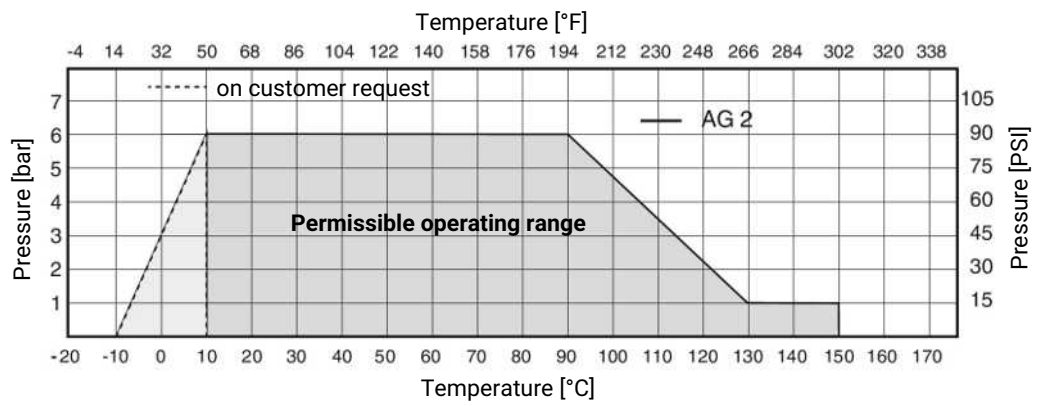

**Kv values:**

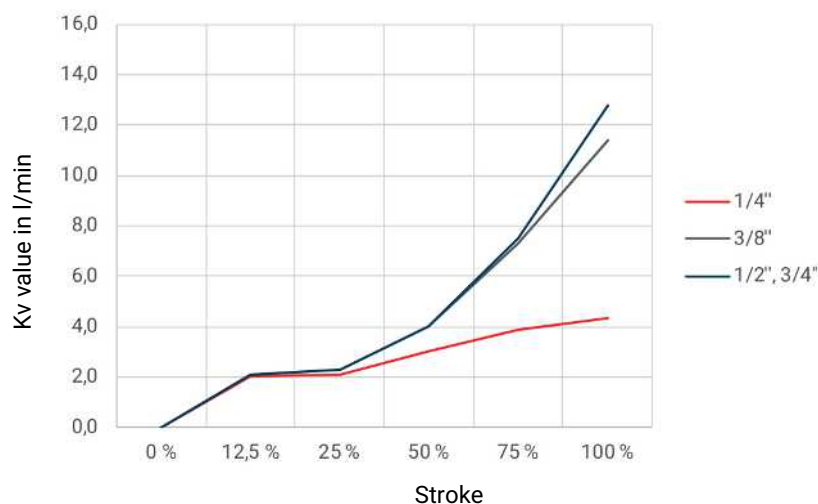

**Equal-percentage, regulating cone code R3234**

Stroke in %	1/4"	3/8"	1/2"	3/4"
0.0	0.0	0.0	0.0	0.0
12.5	2.0	2.1	2.1	2.1
25.0	2.1	2.3	2.3	2.3
50.0	3.0	4.0	4.0	4.0
75.0	3.9	7.3	7.5	7.5
100.0	4.3	11.4	12.8	12.8

**Kv values in l/min**

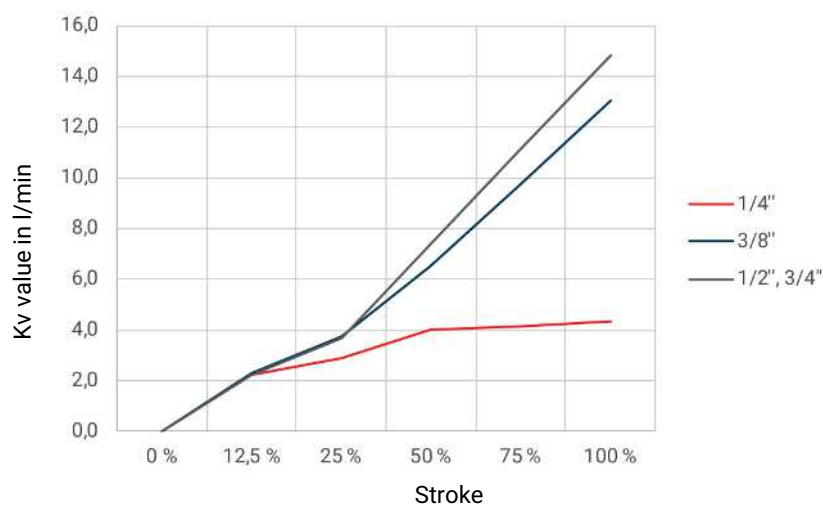

**Linear, regulating cone code R3235**

Stroke in %	1/4"	3/8"	1/2"	3/4"
0.0	0.0	0.0	0.0	0.0
12.5	2.2	2.3	2.3	2.3
25.0	2.9	3.7	3.7	3.7
50.0	4.0	6.5	7.4	7.4
75.0	4.2	9.8	11.1	11.1
100.0	4.3	13.0	14.8	14.8

**Kv values in l/min**

Further Kv value characteristics on request

**Vacuum:**

400 mbar absolute

## Product conformities

<b>Machinery Directive:</b>	2006/42/EC
<b>EMC Directive:</b>	2014/30/EU
<b>Interference resistance:</b>	DIN EN 61000-6-2 (Nov. 2019)
<b>Interference emission:</b>	DIN EN 61000-6-4

## Mechanical data

**Protection class:** IP 65 acc. to EN 60529

**Weight:**

Connection size	Weight
1/4"	660 g
3/8"	660 g
1/2"	600 g
3/4"	600 g

## Duty cycle and service life

**Service life:** **Open/Close duty** – Minimum 1,000,000 switching cycles at room temperature and permissible duty cycle.  
**Control operation** – Class C acc. to EN 15714-2 (± 1,800,000 start-ups).

**Duty cycle:** 60% duty

## Electrical data

### Supply voltage

<b>Voltage:</b>	24 V DC ± 10%
<b>Rating:</b>	≤ 24 W (24 V DC)
<b>Reverse battery protection:</b>	Yes

### Analogue input signals

#### Set value as current signal, control module code S1

<b>Input signal:</b>	4 - 20 mA
<b>Input type:</b>	passive
<b>Input resistance:</b>	50 Ω
<b>Control accuracy:</b>	±1%

#### Set value as voltage signal, control module code V1

<b>Input signal:</b>	0–10 V
<b>Input type:</b>	passive
<b>Input resistance:</b>	110 KΩ
<b>Control accuracy:</b>	±1%

### **Digital input signals**

<b>Function:</b>	Initialization of the positioner
<b>Voltage:</b>	24 V DC
<b>Logic level "1":</b>	> 15 V DC
<b>Logic level "0":</b>	≤ 5 V DC

### **Analogue output signals**

#### **Actual value as current signal, control module code S1**

<b>Output signal:</b>	4 - 20 mA
<b>Output type:</b>	active
<b>Load resistor:</b>	0–650 Ω
<b>Short-circuit proof:</b>	Yes

#### **Actual value as voltage signal, control module code V1**

<b>Output signal:</b>	0–10 V
<b>Output type:</b>	active
<b>Short-circuit proof:</b>	Yes

### **Behaviour in the event of an error**

<b>Function:</b>	In the event of an error the valve moves to the error position. Notes: Moving to the error position is only possible with full power supply. This behaviour is not a safety position. The valve must be operated with a GEMÜ 1571 emergency power supply module (see accessories) to ensure the function in case of voltage loss.
<b>Error position:</b>	Closed

## Dimensions

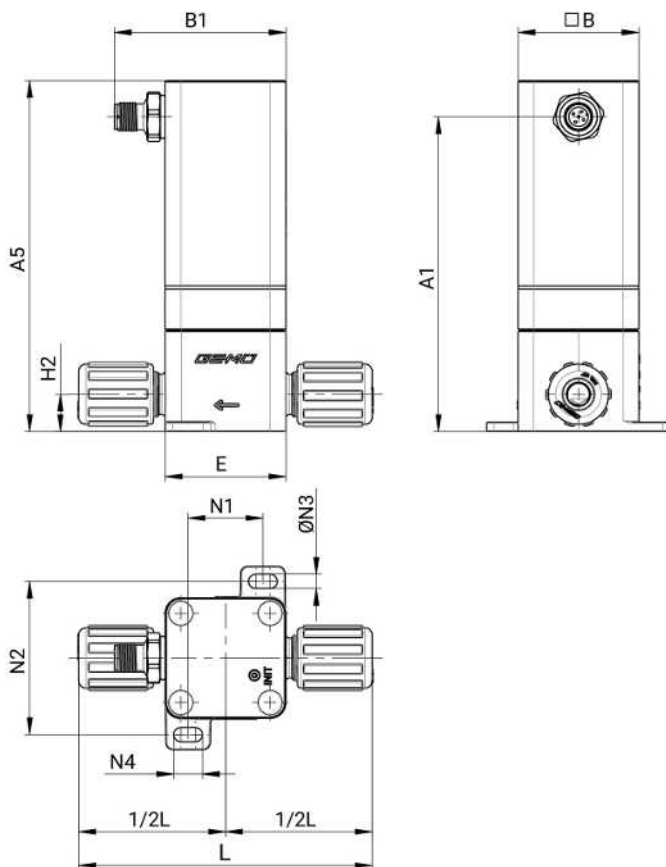

Con- nection size	Actu- ator version	Con- nection	A1	A5	□B	B1	E	H2	L	N1	N2	ØN3	N4
1/4"	2A	Flare	131.0	146.0	50.0	71.0	50.0	16.0	111.0	71.0	49.0	6.0	12.0
		Prime-Lock	131.0	146.0	50.0	71.0	50.0	16.0	109.0	71.0	49.0	6.0	12.0
		Pillar	131.0	146.0	50.0	71.0	50.0	16.0	88.0	71.0	49.0	6.0	12.0
3/8"	2A	Flare	131.0	146.0	50.0	71.0	50.0	16.0	117.8	71.0	49.0	6.0	12.0
		Prime-Lock	131.0	146.0	50.0	71.0	50.0	16.0	113.0	71.0	49.0	6.0	12.0
		Pillar	131.0	146.0	50.0	71.0	50.0	16.0	100.0	71.0	49.0	6.0	12.0
1/2"	2A	Flare	131.0	146.0	50.0	71.0	50.0	16.0	121.6	31.0	63.5	6.0	12.0
		Prime-Lock	131.0	146.0	50.0	71.0	50.0	16.0	120.0	31.0	63.5	6.0	12.0
		Pillar	131.0	146.0	50.0	71.0	50.0	16.0	108.0	71.0	49.0	6.0	12.0
3/4"	2A	Flare	131.0	146.0	50.0	71.0	50.0	16.0	128.0	31.0	63.5	6.0	12.0
		Prime-Lock	131.0	146.0	50.0	71.0	50.0	16.0	128.0	31.0	63.5	6.0	12.0
		Pillar	131.0	146.0	50.0	71.0	50.0	16.0	108.0	71.0	49.0	6.0	12.0

Dimensions in mm



## Electrical connection

### Position of the connectors

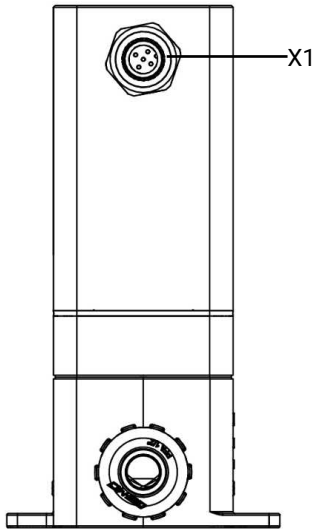

## Electrical connection

### Connection X1

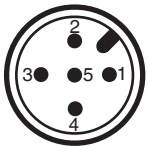

5-pin M12 built-in socket. A-coded

Pin	Signal name
1	24 V supply voltage
2	I+/U+, set value input
3	GND
4	I+/U+, actual value output
5	Digital input 1

## Qualification of the valve

### Bursting pressure at room temperature

Valve	Component	Test conditions	Required criteria
<b>C53</b>	Valve body	Maintain defined water pressure for 10 minutes, if OK, increase water pressure until leakage is detected.	No leakage externally. Bursting pressure = 5.8 x P max. (35.0 bar)

### Service life at room temperature

Valve	Component	Test conditions	Required criteria
<b>C53</b>	Valve	Valves switched at room temperature, medium pressure 6 bar, water, full stroke	No leakage externally or via the seat for up to <b>1 million switching cycles*</b>
<b>C53</b>	Valve	Valves switched at room temperature, medium pressure 6 bar, water, 20% control stroke	No leakage externally or via the seat for up to <b>1 million switching cycles*</b>

### Hot oil inspection

Valve	Component	Test conditions	Required criteria
<b>C53</b>	Valve	Valves switched at 150 °C hot oil, medium pressure 2 bar, full stroke, seals tightly	No leakage externally and via the seat <b>300,000 switching cycles*</b> every 2 weeks

### Hot water test

Valve	Component	Test conditions	Required criteria
<b>C53</b>	Valve	Valves switched at 90 °C hot water, medium pressure 2.1 bar, full stroke, seals tightly	No leakage externally and via the seat <b>200,000 switching cycles*</b> every 2 weeks

### Temperature change test

Valve	Component	Test conditions	Required criteria
<b>C53</b>	Valve	Valves not switched at -15 °C/+70 °C in temperature changes, no medium, no pressure, cycle time 4 hours	Protection class inspection IP 65 passed, no penetration of humidity in the actuator can be detected

### Vacuum inspection

Valve	Component	Test conditions	Required criteria
<b>C53</b>	Valve	Closed for 2 weeks	Valve fully open at -930 mbar (relative)

### Positioner inspection

Valve	Component	Test conditions	Required criteria
<b>C53</b>	Control actuator	Modulation test 10% stroke, 20% force, at room temperature	1.8 million start-ups

\* All concluding tests were carried out at testing pressure at room temperature.  
Seat leak tightness: PSx1.1 =(6.6 bar). External leak tightness: PSx1.5 =(9 bar).

## Accessories



### GEMÜ 1219

#### Cable socket / cable plug M12

The GEMÜ 1219 is a connector (cable socket / cable plug) M12, 5-pin. Straight and/or 90° angled plug type. Defined cable length or with threaded connection without cable. Various materials available for the threaded ring.

#### Ordering information

Description	Length	Material	Item number
5-pin, angle	without cable	PA	88208750
	2 m cable	PA/PUR	88221316
	5 m cable	PA/PUR	88279160
	2 m cable	PA/PTFE	88708098
	5 m cable	PA/PTFE	88708099
	10 m cable	PA / PVC	88708102
5-pin, straight	without cable	PA	88208749
	2 m cable	PA/PUR	88353742
	5 m cable	PA/PUR	88440263
	2 m cable	PA/PTFE	88708100
	5 m cable	PA/PTFE	88708101



### GEMÜ 1571

#### Emergency power supply module

The GEMÜ 1571 capacitive emergency power supply module is suitable for valves with motorized actuators such as GEMÜ eSyStep and eSyDrive as well as the GEMÜ C53 iComLine control valve. In the event of a power failure, the product provides an uninterrupted power supply so that the valve can be moved to the safety position. The emergency power supply module is available individually or with an expansion module and can supply several valves. The input and output voltage is 24 V.

#### Ordering information

GEMÜ 1571 emergency power supply module			
Input voltage	Output voltage	Capacity	Item number
24 V	24 V	1700 Ws	88660398
24 V	24 V	13200 Ws	88751062



### GEMÜ 1573

#### Switching power supply unit

The GEMÜ 1573 switching power supply unit converts unstable input voltages from 100 to 240 V AC into a continuous DC voltage. It can be used as an accessory for valves with motorized actuators e. g. GEMÜ eSyLite, eSyStep und eSyDrive and for additional devices with a 24 V DC power supply. Different power levels, output currents and a 48 V DC version for servoDrive actuators are available.

#### Ordering information

Description	Input voltage	Output voltage	Output current	Item number
Power supply unit 24 V, 5 A	100–240 V AC	24 V DC	5 A	88660400
Power supply unit 24 V, 10 A	100–240 V AC	24 V DC	10 A	88660401



GEMÜ Gebr. Müller Apparatebau GmbH & Co. KG  
Fritz-Müller-Straße 6-8, 74653 Ingelfingen-Criesbach, Germany  
Phone +49 (0) 7940 1230 · info@gemue.de  
www.gemu-group.com